



Product catalogue



2013

Contents

Drapes and sets	3
X-ray detectable towels, swabs and sponges	29
Minor procedure sets	33
Surgical gowns	45
Protective apparel	53
Surgical masks and caps	61
Gloves	69
Wound care	93
Bandages	101





Drapes and sets

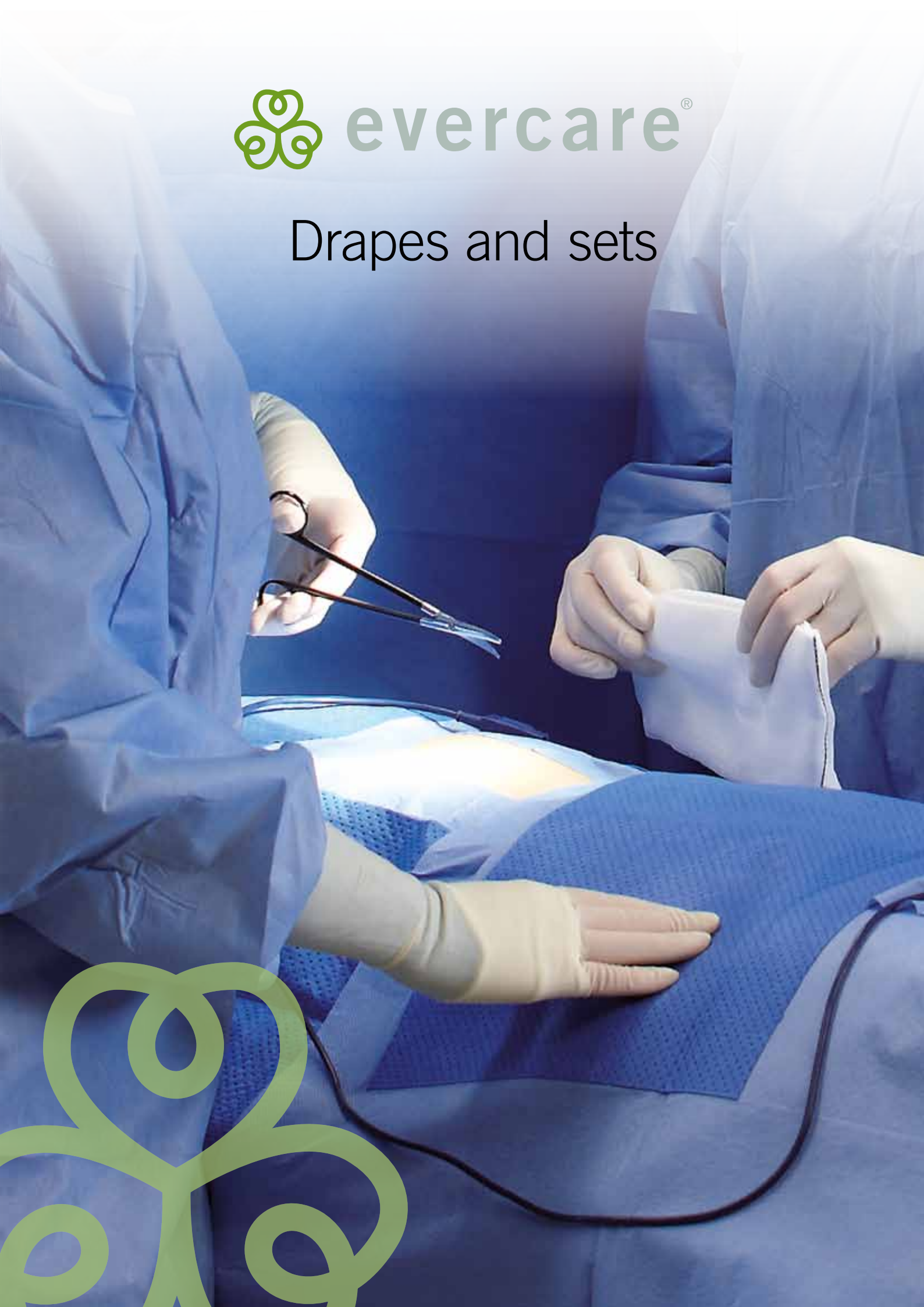

Safety

Practicality

Comfort

- Safely strong – impermeable
- Plenty of absorbency – extra large absorbent patches
- Very low linting
- Very good drapeability
- Stays well in place, is not slippery
- Low reflections
- High puncture resistance – very durable

- 1 Large and very efficient absorbent patches, new structure
- 2 Blue/grey nonwoven, very low linting
- 3 A highly elastic multicomponent pe-film moisture barrier – puncture resistance
- 4 White backsheet with very low linting – more comfort to the patient, more strength

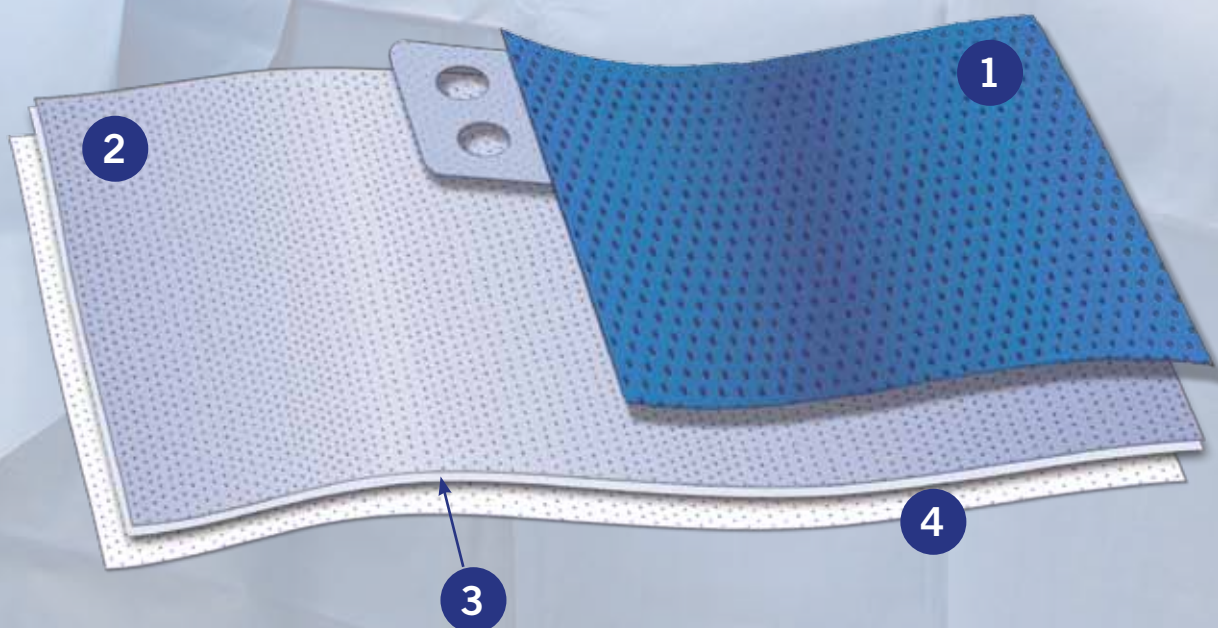







Complies to EN 13795.



Easily identifiable integrated tube holders in drapes with absorbent patch



Material chart

-  Absorbent and impermeable multilayer material
-  Absorbent and impermeable 2-layer material
-  Absorbent and impermeable reinforcement material (absorbent patch)
-  Polyethylene film
-  Elastic material
-  Adhesive edge

Universal set with Mayo stand cover, absorbent patches size Large

REF 1011-02

- 1 op-tape, 9 x 50 cm
- 1 Mayo stand cover 78 x 145 cm, reinforced
- 4 hand towels
- 2 adhesive drapes 75 x 90 cm, absorbent patches Large 25 x 60 cm, tube holders
- 1 adhesive drape medium 180 x 180 cm, absorbent patch Large 25 x 60 cm, tube holders
- 1 adhesive drape large 150 x 240 cm, absorbent patch Large 25 x 60 cm, tube holders
- 1 instrument table cover 150 x 190 cm
- Pack count: 1/5/10

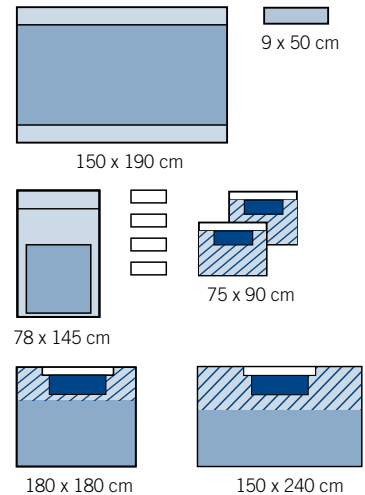

Universal set without Mayo stand cover, absorbent patches size Large

REF 1015-02

- 1 op-tape 9 x 50 cm
- 4 hand towels
- 2 adhesive drapes 75 x 90 cm, absorbent patches Large 25 x 60 cm, tube holders
- 1 adhesive drape medium 180 x 180 cm, absorbent patch Large 25 x 60 cm, tube holders
- 1 adhesive drape large 150 x 240 cm, absorbent patch 25 x 60 cm, tube holders
- 1 instrument table cover 150 x 190 cm
- Pack count: 1/6/12

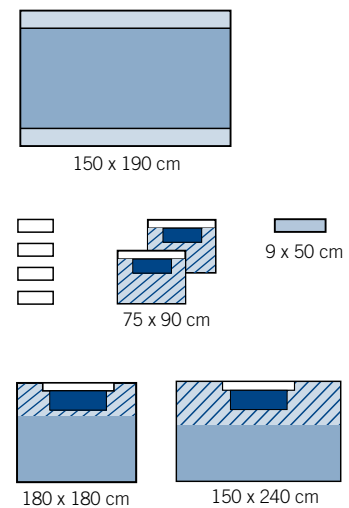

Universal set with Mayo stand cover

REF 1005-02

- 1 op-tape 9 x 50 cm
- 1 Mayo stand cover 78 x 145 cm, reinforced, telescopically folded
- 4 hand towels
- 2 adhesive drapes 75 x 90 cm, 2-layer
- 1 adhesive drape medium 180 x 180 cm, 2-layer
- 1 adhesive drape large 150 x 240 cm, 2-layer
- 1 instrument table cover 150 x 190 cm
- Pack count: 1/6/12

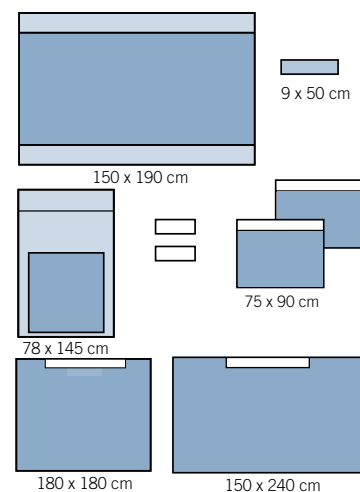

Drapes and sets

Universal sets

Paediatric universal set

REF 1030-02

- 1 op-tape 9 x 50 cm
- 1 Mayo stand cover 78 x 145 cm, reinforced
- 4 hand towels
- 2 adhesive drapes 75 x 75 cm
- 1 adhesive drape medium 180 x 180 cm
- 1 adhesive drape large 150 x 240 cm
- 1 instrument table cover 150 x 190 cm
- Pack count: 1/7/14

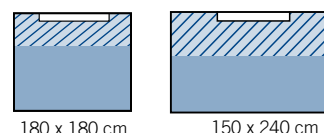
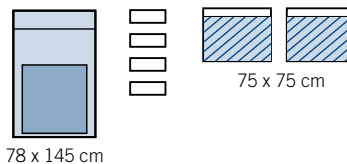
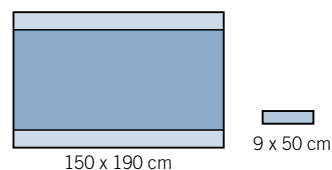

Universal set with Mayo stand cover, absorbent patches size Medium

REF 1010-02

- 1 op-tape 9 x 50 cm
- 1 Mayo stand cover 78 x 145 cm, reinforced
- 4 hand towels
- 2 adhesive drapes 75 x 90 cm, absorbent patches Medium 15 x 50 cm, tube holders
- 1 adhesive drape medium 180 x 180 cm, absorbent patches Medium 15 x 50 cm, tube holders
- 1 adhesive drape large 150 x 240 cm
- 1 instrument table cover 150 x 190 cm
- Pack counts: 1/5/10

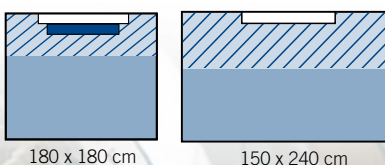
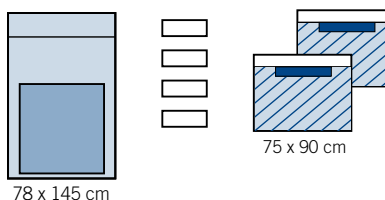
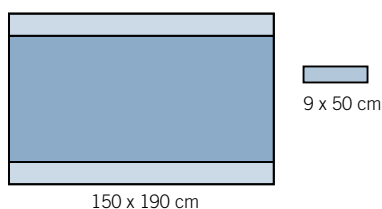

Split sheet set

REF 1050-02

- 1 Mayo stand cover 78 x 145 cm, reinforced
- 4 hand towels
- 1 op-tape 9 x 50 cm
- 1 adhesive drape 75 x 90 cm
- 1 adhesive split sheet 230 x 260 cm, split 20 x 100 cm, absorbent patch 75 x 140 cm, tube holders
- 1 adhesive drape large, 150 x 240 cm
- 1 instrument table cover 150 x 190 cm
- Pack count: 1/4/8

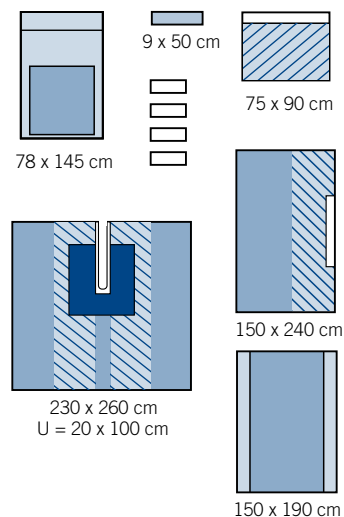

Split sheet set

REF 1051-02

- 1 Mayo stand cover 78 x 145 cm, reinforced
- 4 hand towels
- 1 op-tape 9 x 50 cm
- 1 adhesive drape 75 x 90 cm
- 1 adhesive split sheet 230 x 260 cm, split 20 x 100 cm, absorbent patch 75 x 140 cm, tube holders, split sheet folded so that the bottom of the split is visible
- 1 adhesive drape large, 150 x 240 cm, absorbent patch 25 x 60 cm, tube holders
- 1 instrument table cover 150 x 190 cm
- Pack count: 1/4/8

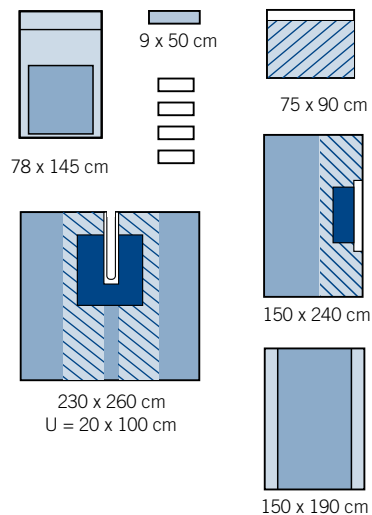

Drapes and sets

Orthopaedic sets

Hip set, Standard

REF 1210-02

- 1 Mayo stand cover 78 x 145 cm, reinforced
- 4 hand towels
- 1 adhesive drape medium 180 x 180 cm, absorbent patch 15 x 50 cm, tube holders
- 1 elastic stockinette 30 x 120 cm
- 1 elastic support bandage 12 cm x 6 m
- 2 adhesive drapes 75 x 90 cm
- 3 op-tapes 9 x 50 cm
- 1 adhesive split sheet 230 x 260 cm, split 20 x 100 cm, absorbent patch 75 x 140 cm, tube holders
- 1 adhesive drape 150 x 240 cm
- 1 instrument table cover 150 x 190 cm
- Pack count: 1/3/6

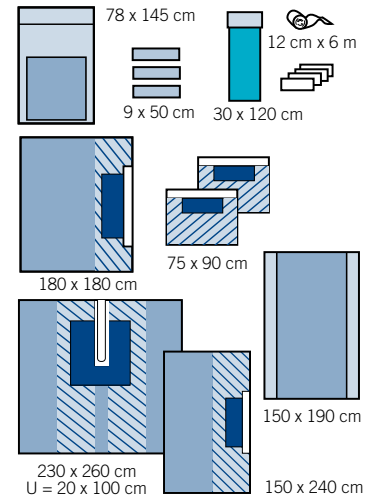

HIP set, Large

REF 1215-02

- 2 Mayo stand cover 78 x 145 cm, reinforced
- 4 hand towels
- 1 adhesive drape medium 180 x 180 cm, absorbent patch 15 x 50 cm, tube holders
- 1 elastic stockinette 30 x 120 cm
- 1 elastic support bandage 12 cm x 6 m
- 1 instrument table cover 100 x 150 cm, folded
- 2 utility drapes 75 x 80 cm
- 3 op-tapes 9 x 50 cm
- 3 adhesive drapes 75 x 90 cm
- 1 fluid collection pouch 30 x 40 cm
- 1 adhesive split sheet 230 x 260 cm, split 20 x 100 cm, absorbent patch 75 x 140 cm, tube holders
- 1 adhesive drape large, 150 x 240 cm
- 1 instrument table cover 150 x 190 cm
- Pack count: 1/3/6

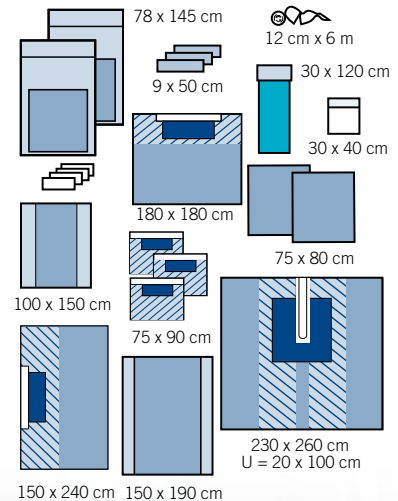

Hip set, Special

REF 1220-02

- 2 Mayo stand covers 78 x 145 cm, reinforced
- 4 hand towels
- 1 adhesive drape medium 180 x 180 cm, absorbent patch 15 x 50 cm, tube holders
- 1 elastic support bandage 12 cm x 6 m
- 1 elastic stockinette 30 x 120 cm
- 5 op-tapes 9 x 50 cm
- 3 adhesive drapes 75 x 90 cm
- 1 adhesive split sheet, 230 x 260 cm, split 20 x 100 cm, abs. patch 75 x 140 cm, tube holders
- 1 adhesive drape large, 150 x 240 cm
- 1 instrument table cover 150 x 190 cm
- Pack count: 1/3/6

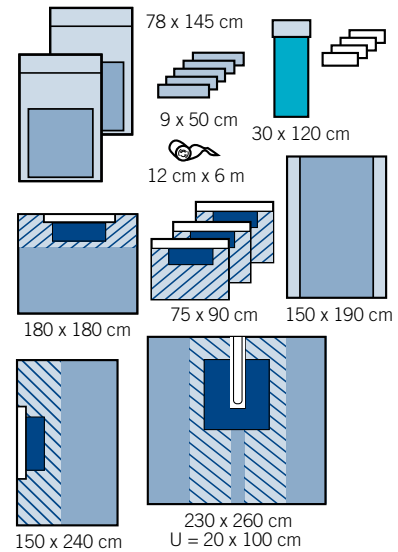

Vertical drape set, Small

REF 1225-02

- 4 hand towels
- 1 Mayo stand cover 78 x 145 cm, reinforced
- 1 vertical drape 330 x 240 cm, incision film 40 x 30 cm, integrated fluid collection pouch with sieve and bottom outlet, 2 tube holders and 2 two-compartment suction/diathermy pouches, 24 x 24 cm
- 1 instrument table cover 150 x 190 cm
- Pack count: 1/7/14

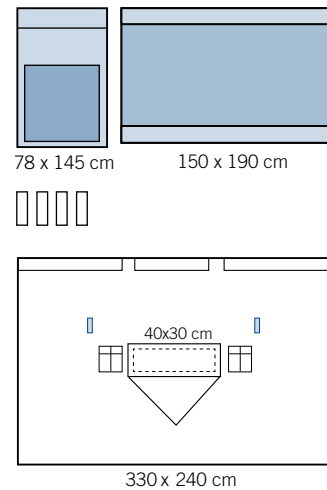

Vertical drape set, Large

REF 1226-02

- 4 hand towels
- 1 Mayo stand cover 78 x 145 cm, reinforced
- 1 vertical drape 330 x 240 cm, incision film 86 x 25 cm, integrated fluid collection pouch with sieve and bottom outlet, 2 tube holders and 2 two-compartment suction/diathermy pouches, 24 x 24 cm
- 1 instrument table cover 150 x 190 cm
- Pack count: 1/7/14

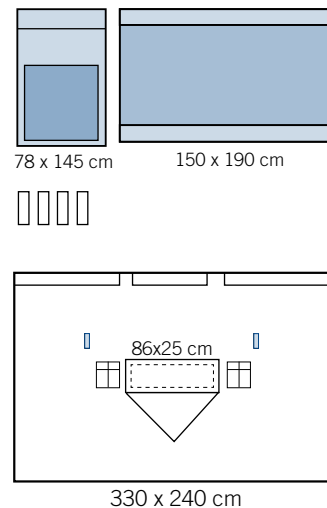

Extremity set

REF 1230-02

- 4 hand towels
- 1 Mayo stand cover 78 x 145 cm, reinforced
- 2 op-tapes 9 x 50 cm
- 1 instrument table cover 150 x 190 cm, folded
- 1 adhesive drape sheet 75 x 90 cm
- 1 extremity drape 230 x 300 cm, elastic aperture 7 cm, absorbent patch 50 x 100 cm, tube holders
- 1 instrument table cover 150 x 190 cm
- Pack count: 1/4/8

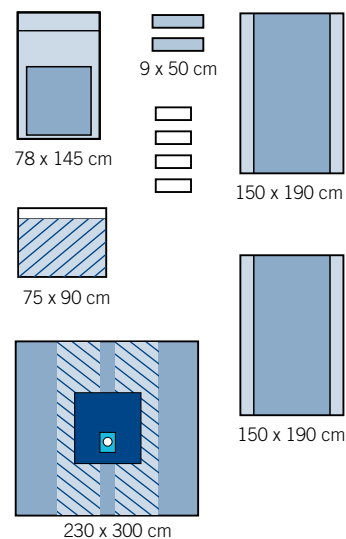

Extremity set

REF 1231-02

- 1 Mayo stand cover 78 x 145 cm, reinforced
- 4 hand towels
- 1 instrument table cover 150 x 190 cm, folded
- 2 op-tapes 9 x 50 cm
- 1 elastic stockinette 22 x 75 cm
- 1 extremity drape 230 x 300 cm, elastic aperture 7 cm, absorbent patch 50 x 100 cm, tube holders
- 1 instrument table cover 150 x 190 cm
- Pack count: 1/4/8

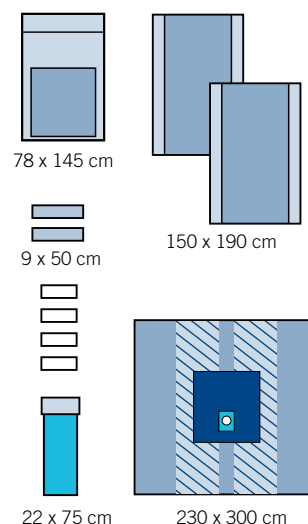

Extremity set

REF 1233-02

- 1 Mayo stand cover, 78 x 145 cm, reinforced
- 2 op-tapes 9 x 50 cm
- 4 hand towels
- 1 instrument table cover 150 x 190 cm, folded
- 1 adhesive drape 75 x 90 cm
- 1 elastic support bandage 10 cm x 4,5 m
- 1 extremity drape 230 x 300 cm, elastic aperture 7 cm, absorbent patch 50 x 100 cm, tube holders
- 1 instrument table cover 150 x 190 cm
- Pack count: 1/4/8

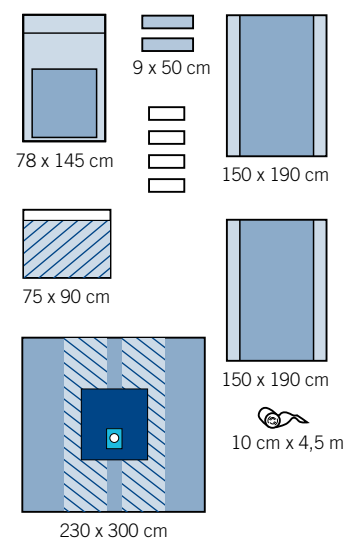

Drapes and sets

Orthopaedic sets

Hand/foot set

REF 1232-02

- 1 Mayo stand cover 78 x 145 cm, reinforced
- 1 extremity drape 230 x 300 cm, elastic aperture 3,5 cm, absorbent patch 50 x 100 cm, tube holders
- 1 instrument table cover 150 x 190 cm
- Pack count: 1/6/12

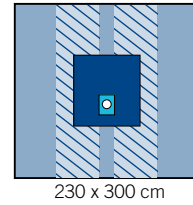
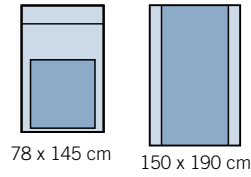

Knee arthroscopy set

REF 1235-02

- 1 Mayo stand cover 78 x 145 cm, reinforced
- 4 hand towels
- 2 op-tapes 9 x 50 cm
- 1 instrument table cover 150 x 190 cm, folded
- 1 elastic stockinette 22 x 75 cm
- 1 knee arthroscopy drape with fluid collection pouch, 230 x 320 cm
- 1 instrument table cover 150 x 190 cm
- Pack count: 1/4/8

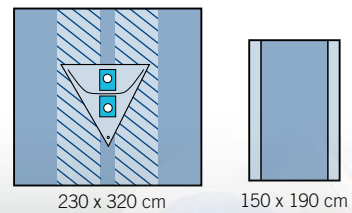
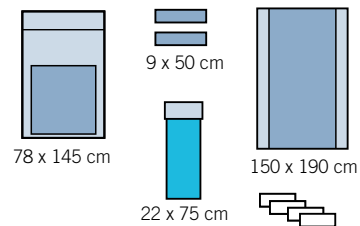

Urology and gynaecology sets

Gyn/Cyst set

REF 1250-01

- 1 utility drape, 75 x 80 cm
- 2 leggings, 75 x 120 cm
- 1 gyn/cyst drape 75 x 175 cm, aperture 9 x 15 cm
- 1 instrument table cover, 150 x 190 cm
- Pack count: 1/5/20

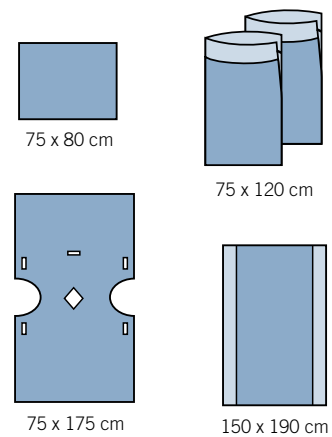

Gynaecology set

REF 1251-02

- 1 Mayo stand cover 78 x 145 cm, reinforced
- 2 hand towels
- 1 tube holder 2,5 x 30 cm
- 1 gynaecology drape with integrated fluid collection pouch, 60 x 120 cm, aperture 9 x 12 cm.
- 1 gynaecology drape 270/230 x 260 cm, aperture 24 x 21 cm, integrated leggings
- 1 Instrument table cover 150 x 190 cm
- Pack count: 1/6/12

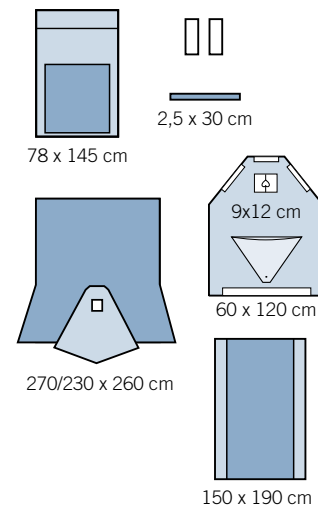

Gynaecology set

REF 1253-01

- 3 hand towel
- 1 drape sheet 75 x 120 cm
- 2 leggings 75 x 120 cm
- 1 gyn upper drape 115 x 150 cm
- 1 gyn lower drape 140 x 150 cm
- 1 instrument table cover 100 x 150 cm
- Pack count: 1/4/16

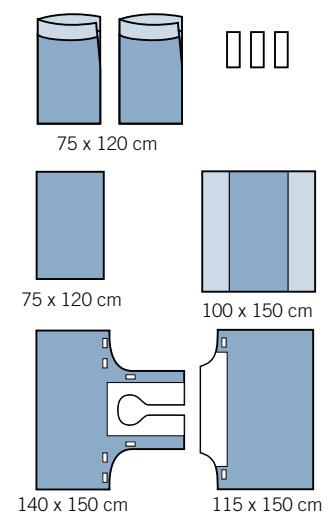

Urology and gynaecology sets

Delivery set

REF 1255-01

- 1 instrument table cover (for under the mother), 90 x 150 cm
- 1 drape (stitching sheet) 75 x 120 cm
- 1 bed pad 60 x 90 cm
- 1 absorbent sheet (baby sheet) 56 x 75 cm
- 6 towels 21 x 25 cm
- 1 bed pad 60 x 60 cm
- Pack count: 1/12

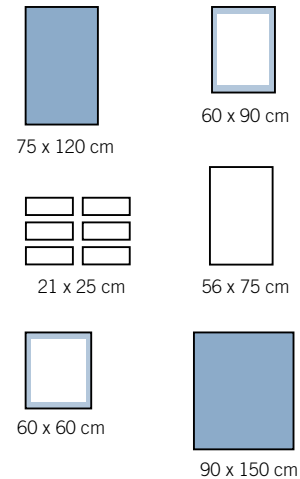

C-section set

REF 1260-02

- 4 hand towels
- 1 op-tape 9 x 50 cm
- 1 Mayo stand cover 78 x 145 cm, reinforced
- 1 baby sheet 75 x 120 cm
- 1 C-section drape 186/250 x 330 cm, fluid collection pouch, incision film, Ø 16 x 18 cm
- 1 instrument table cover 150 x 190 cm
- Pack count: 1/5/10

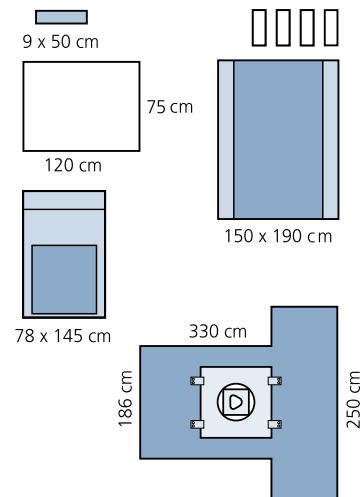

C-section set

REF 1261-02

- 1 Mayo stand cover 78 x 145 cm, reinforced
- 4 hand towels
- 1 op-tapes 9 x 50 cm
- 1 baby sheet 75 x 120 cm
- 1 C-section drape 330 x 230 cm, fluid collection pouch, integrated incision film 36 x 36 cm and tube holders
- 1 instrument table cover 150 x 190 cm
- Pack count: 1/5/10

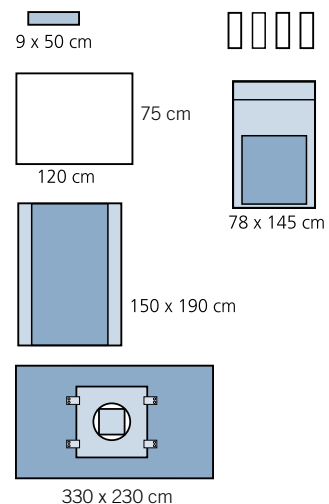

Urology and gynaecology sets

TUR set

REF 1270-02

- 1 op-tape 9 x 50 cm
- 1 utility drape 75 x 80 cm
- 2 leggings 75 x 120 cm
- 1 TUR-drape 75 x 175 cm
- 1 instrument table cover 150 x 190 cm
- Pack count: 1/4/16

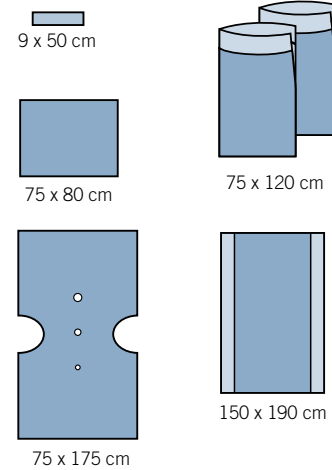

TUR set

REF 1272-01

- 1 tube holder velcron 2,5 x 30 cm
- 4 hand towels
- 1 op-tape 9 x 50 cm
- 1 TUR-drape 175/270 x 170 cm all-in-one, with integrated finger cot, aperture 6 and self-adhesive aperture 8 cm, integrated fluid collection pouch with sieve and outlet
- 1 instrument table cover 150 x 190 cm
- Pack count: 1/6/12

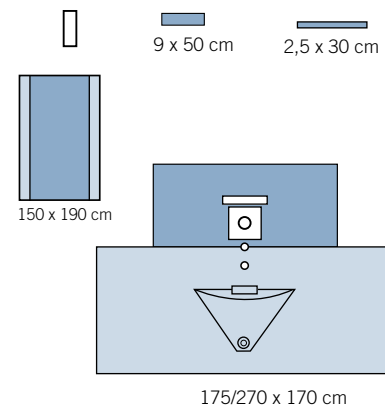

ENT set

REF 1238-02

- 4 hand towels
- 1 Mayo stand cover 78 x 145 cm, reinforced
- 2 op-tapes 9 x 50 cm
- 1 adhesive drape 75 x 90 cm, absorbent patch 15 x 50 cm, tube holders
- 1 utility drape 75 x 80 cm
- 1 adhesive split sheet 150 x 250 cm split 7 x 70 cm, absorbent patch 50 x 50 cm, tube holders
- 1 instrument table cover 150 x 190 cm
- Pack count: 1/5/10

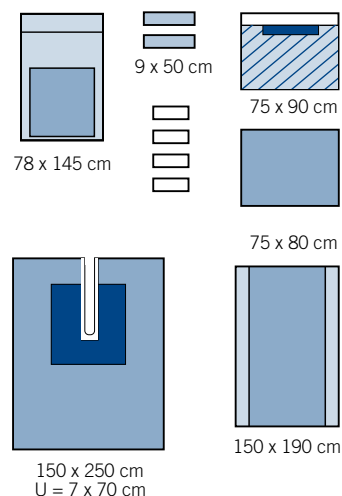

Angiography set

REF 1240-01

- 1 instrument table cover 100 x 150 cm, folded
- 2 hand towels
- 1 absorbent sheet 50 x 80 cm
- 1 adhesive drape 50 x 60 cm
- 1 angiography drape 230 x 370 cm, with transparent side panels, absorbent patch 75 x 70 cm
- 1 instrument table cover 150 x 190 cm
- Pack count:1/5/10

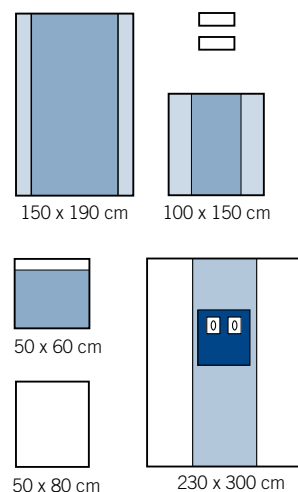

Angiography set

REF 1241-01

- 1 instrument table cover 150 x 140 cm, folded
- 2 hand towels
- 1 absorbent drape 50 x 80 cm
- 1 adhesive drape 50 x 60 cm
- 1 angiography drape, 230 x 330 cm, with transparent side panels, apertures 5 x 7 cm (2 pcs) and 7 x 10 cm (2 pcs)
- 1 instrument table cover 150 x 140 cm
- Pack count:1/5/10

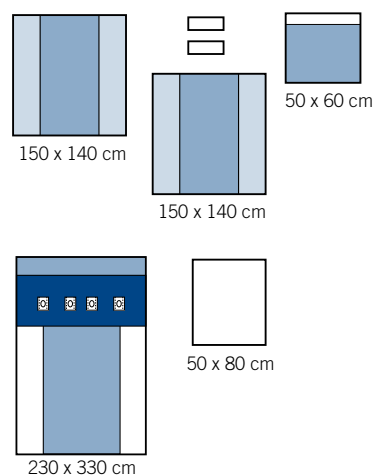

Dental set

REF 1290-02

- 1 dental drape 100 x 150 cm
- 1 op-tape 9 x 50 cm
- 2 tube covers 8 x 120 cm
- 1 instrument table cover 75 x 100 cm
- Pack count: 1/14/56

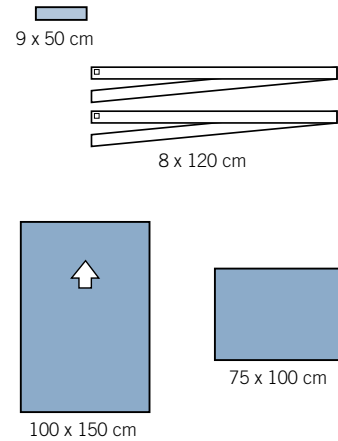

Head/Neck drape

REF 1291-02

- 2 head/neck drapes 175 x 127 x 150 cm and 103 x 106 cm
- 1 instrument table cover 78 x 70 cm
- 1 op-tape 9 x 50 cm
- Pack count: 1/10/40

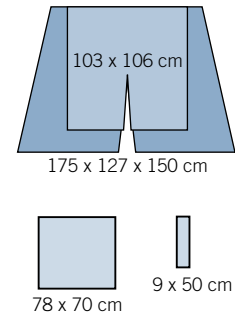

Laparoscopy set

REF 1267-02

- 1 Mayo stand cover 78 x 145 cm, reinforced
- 4 hand towels
- 2 op-tapes 9 x 50 cm
- 1 laparoscopy drape 230 x 300 cm, aperture 31 x 35 cm, absorbent patch 75 x 80 cm, tube holders
- 1 instrument table cover 150 x 190 cm
- Pack count: 1/7/14

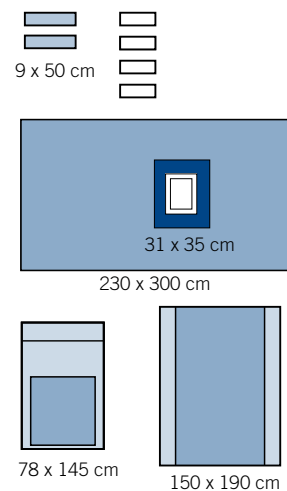

Drapes and sets

Ophthalmic sets

Ophthalmic set

REF 1280-01

- 1 hand towel
- 1 ophthalmic drape 150 x 140 cm, with fluid collection pouch and integrated incision film
- 1 instrument table cover 150 x 140 cm
- Pack count: 1/7/28

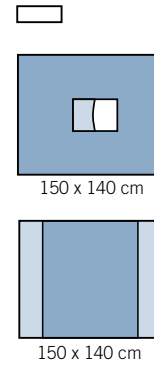

Ophthalmic set

REF 1281-01

- 1 hand towel
- 1 ophthalmic drape 150 x 140 cm, fluid collection pouch and integrated incision film with oval aperture 3,5 x 6,5 cm
- 1 instrument table cover 150 x 140 cm
- Pack count: 1/7/28

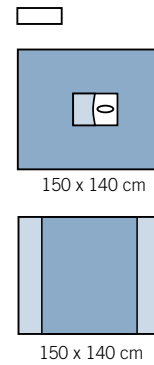

Ophthalmic set

REF 1282-01

- 1 incision film 10 x 12 cm
- 1 ophthalmic drape 150 x 180 cm, fluid collection pouches, oval aperture 5 x 7 cm
- 1 instrument table cover 150 x 140 cm
- Pack count: 1/7/28

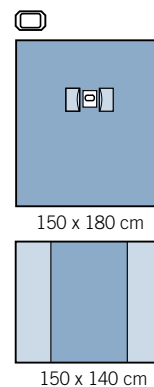

Adhesive split sheets

REF 1310-01

- 150 x 250 cm, split 7 x 70 cm, absorbent patch 50 x 50 cm, tube holders
- Pack count: 1/10/40

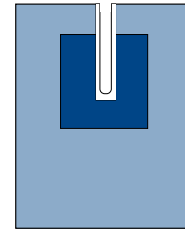

150 x 250 cm
U = 7 x 70 cm

REF 1315-01

- 230 x 260 cm, split 20 x 100 cm, absorbent patch 75 x 140 cm, tube holders
- Pack count: 1/8/16

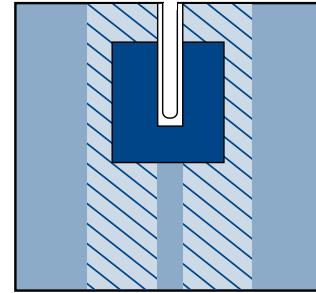

230 x 260 cm
U = 20 x 100 cm

REF 1316-01

- 230 x 260 cm, split 20 x 100 cm, absorbent patch 75 x 140 cm, tube holders, folded so that bottom of the split is visible
- Pack count: 1/8/16

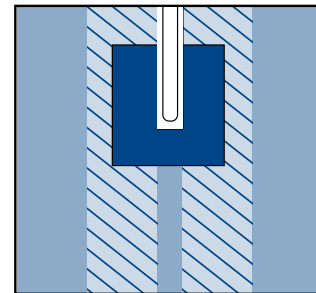

230 x 260 cm
U = 20 x 100 cm

Hand/foot drapes

REF 1320-01

- 150 x 180 cm, elastic aperture Ø 3,5 cm, absorbent patch 50 x 100 cm, tube holders
- Pack count: 1/17/34

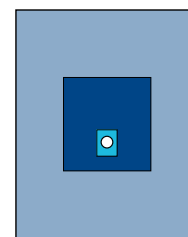

150 x 180 cm

REF 1324-01

- 230 x 300 cm, elastic aperture Ø 3,5 cm, absorbent patch 50 x 100 cm, tube holders
- Pack count: 1/8/16

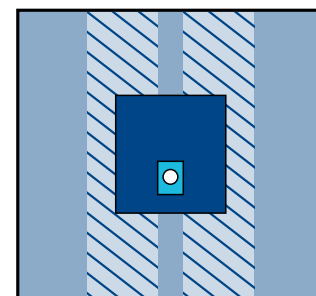

230 x 300 cm

Drapes and sets

Speciality drapes

Extremity drape

REF 1325-01

- 230 x 300 cm, elastic aperture \varnothing 7 cm, absorbent patch 50 x 100 cm, tube holders
- Pack count: 1/8/16

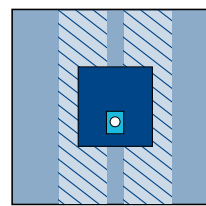

230 x 300 cm

Vertical drapes

REF 1330-01

- 330 x 240 cm, incision film 40 x 30 cm, integrated fluid collection pouch with sieve and bottom outlet, 2 tube holders and 2 two-compartment suction/diathermy pouches, 24 x 24 cm
- Pack count: 1/14/28

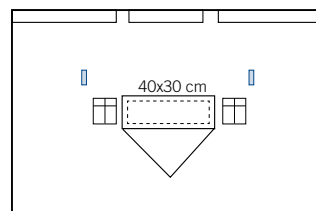

330 x 240 cm

REF 1332-01

- 330 x 240 cm, incision film 86 x 25 cm, integrated fluid collection pouch with sieve and bottom outlet, 2 tube holders and 2 two-compartment suction/diathermy pouches, 24 x 24 cm
- Pack count: 1/10/20

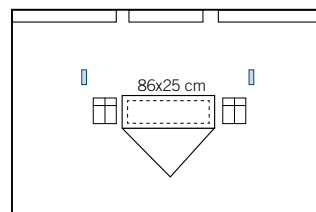

330 x 240 cm

Lower vascular drape (Split sheet with genital cover)

REF 1317-01

- 230 x 260 cm split 20 x 100 cm
- Pack count: 1/12/24

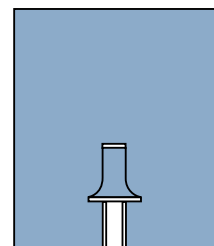

230 x 260 cm
U = 20 x 100 cm

Angiography drape

REF 1340-01

- 230 x 300 cm, transparent side panels, absorbent patch 75 x 70 cm
- Pack count: 1/15/30

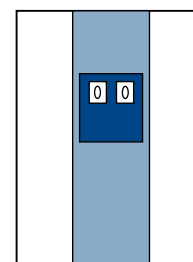

230 x 300 cm

Perineal drape

REF 1356-01

- 75 x 120 cm, aperture 8 x 12 cm, splits and adhesive tapes at edges
- 75 x 90 cm utility drape
- Pack count: 1/17/68

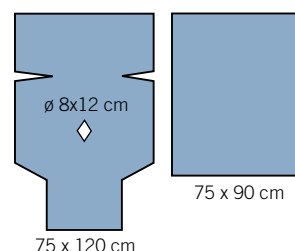

75 x 120 cm

75 x 90 cm

Laparoscopy drapes

REF 1365-01

- 230 x 300 cm, triangular aperture 25 x 20 cm
- Pack count: 1/9/18

REF 1366-01

- 230 x 300 cm, aperture 20 x 31 cm
- Pack count: 1/9/18

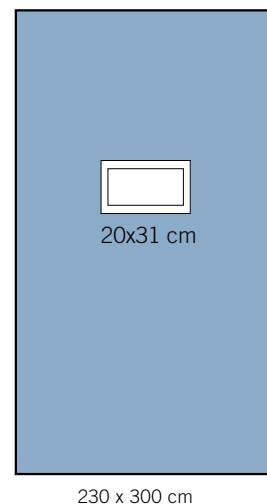
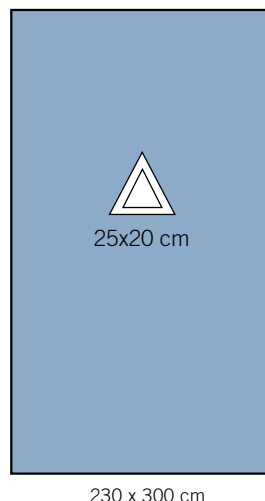

Thoracic drape

REF 1375-01

- 220/300 x 330 cm, aperture 32 x 40 cm, with incision film and fluid collection pouch
- Pack count: 1/7/14

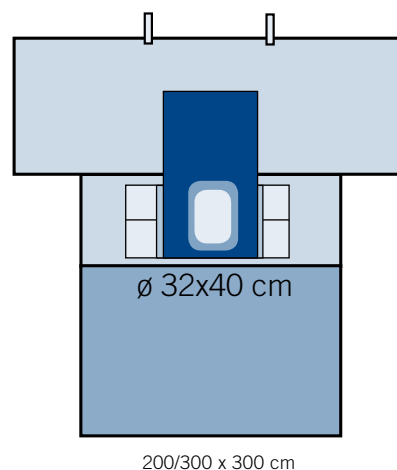

Under buttock drape

REF 1741-01

- 75 x 100 cm
- Pack counts: 1/25/100

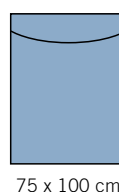

Dislocation bag

REF 1878

- 120 x 75 cm
- Pack counts: 1/20/80

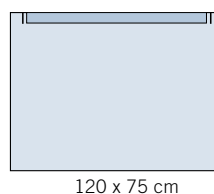

Utility drapes and adhesive drapes

Utility drapes

REF 1410-01

50 x 60 cm
Pack count: 1/45/180

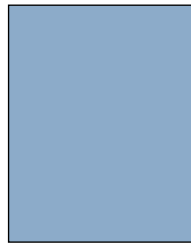

50 x 60 cm

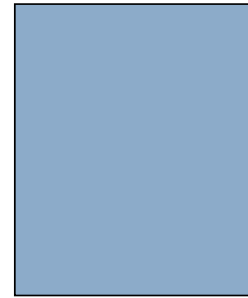

75 x 90 cm

REF 1415-01

75 x 90 cm
Pack count: 1/25/100

Adhesive drape sheets

REF 1455-02

50 x 60 cm
Pack count: 1/40/160

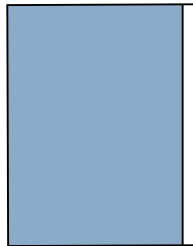

50 x 60 cm

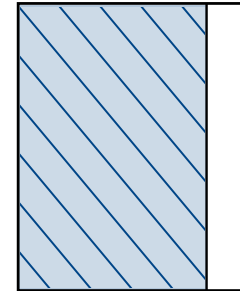

75 x 90 cm

REF 1460-02

75 x 90 cm
Pack count: 1/16/64

Absorbent drape

REF 1463-01

70 x 60 cm
Pack count: 1/18/72



70 x 60 cm

Adhesive drape medium

REF 1465-02

180 x 180 cm
Pack count: 1/8/32

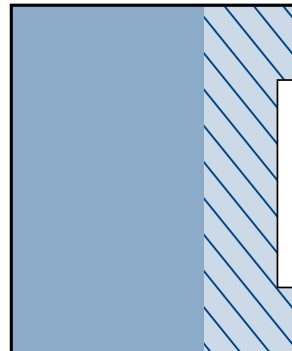

180 x 180 cm

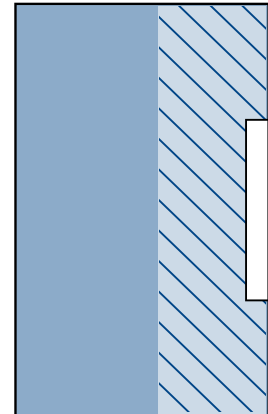

150 x 240 cm

Adhesive drape large

REF 1470-02

150 x 240 cm
Pack count: 1/8/32

Aperture drapes and adhesive aperture drapes

Aperture drapes

REF 1555-01

50 x 60 cm, Ø 6 x 8 cm
Pack count: 1/45/180

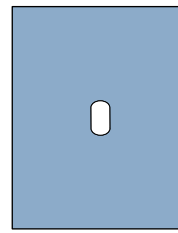

50 x 60 cm
Ø 6 x 8 cm

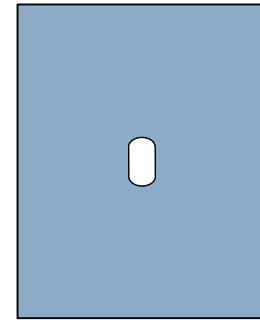

75 x 90 cm
Ø 6 x 8 cm

REF 1565-01

75 x 90 cm, Ø 6 x 8 cm
Pack count: 1/25/100

Adhesive aperture drapes

REF 1505-01

50 x 60 cm, Ø 6 x 8 cm
Pack count: 1/45/180

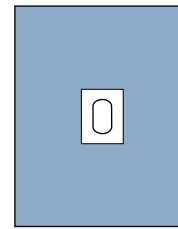

50 x 60 cm
Ø 6 x 8 cm

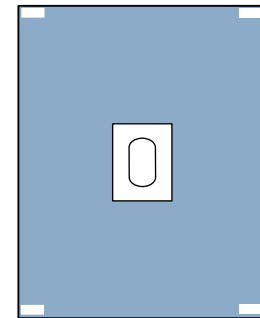

75 x 80 cm
Ø 6 x 15 cm

REF 1510-01

75 x 80 cm, Ø 6 x 15 cm (epidural drape)
Pack count: 1/25/100

REF 1515-01

75 x 90 cm, Ø 6 x 8 cm
Pack count: 1/25/100

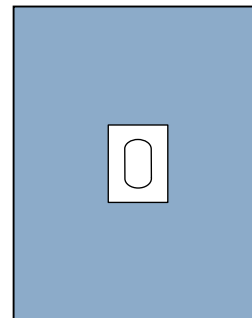

75 x 90 cm
Ø 6 x 8 cm

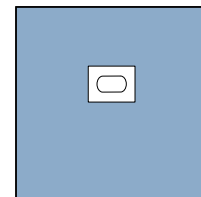

120 x 150 cm
Ø 5 x 7 cm

REF 1520-01

120 x 150 cm, Ø 5 x 7 cm
Pack count: 1/20/80

REF 1525-01

150 x 180 cm, Ø 5 x 7 cm
Pack count: 1/14/56

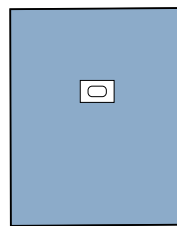

150 x 180 cm
Ø 5 x 7 cm

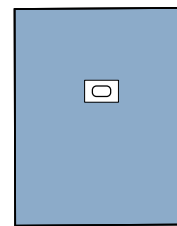

150 x 180 cm
Ø 6 x 15 cm

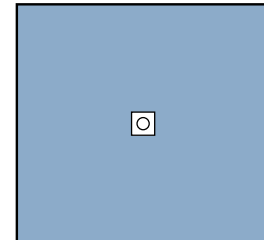

230 x 250 cm
Ø 12 cm

REF 1530-01

150 x 180 cm, Ø 6 x 15 cm
Pack count: 1/12/48

REF 1535-01

230 x 250 cm, Ø 12 cm
Pack count: 1/8/32

Variable aperture drapes

1512-01

50 x 70 cm
Pack count: 1/35/140

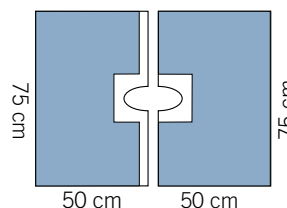

1513-01

75 x 100 cm
Pack count: 1/20/80

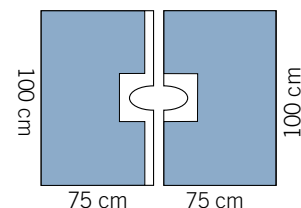
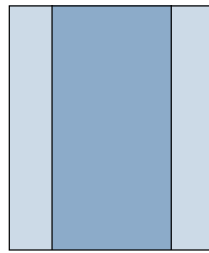

Table covers and components

Instrument table covers

REF 1715-01

100 x 150 cm
Pack count: 1/18/72



100 x 150 cm

REF 1720-01

140 x 150 cm
Pack count: 1/16/64

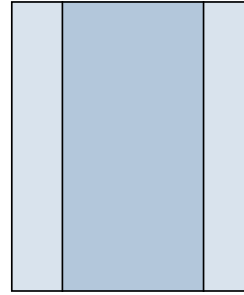

140 x 150 cm

REF 1725-01

150 x 190 cm
Pack count: 1/15/60

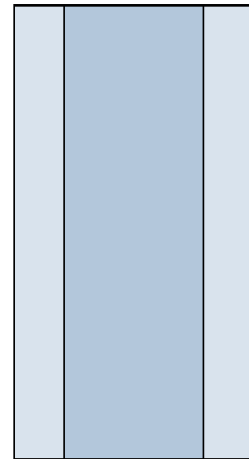

150 x 190 cm

Mayo stand cover, reinforced

REF 1712-01

78 x 145 cm
Pack count: 1/20/80

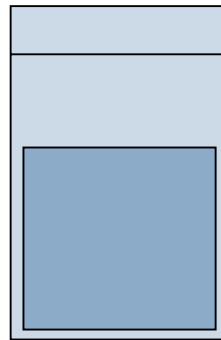

78 x 145 cm

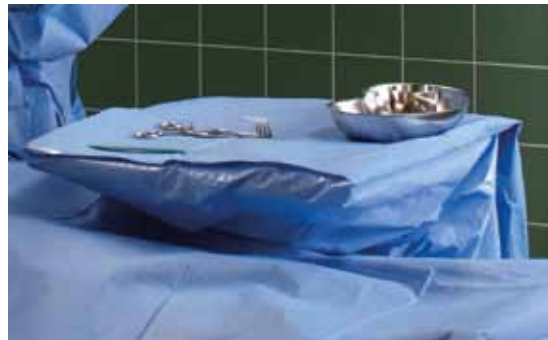

Adhesive Op-tapes

REF 1495-02

9 x 50 cm
Pack count: 1/100/400



9 x 50 cm

REF 1496-02

9 x 50 cm, 2 pcs/bag
Pack count: 2/120/480



9 x 50 cm
2 pcs

Tube holder

REF 1498

2,5 x 30 cm
Pack count: 1/60/240



2,5 x 30 cm

Seat cover

REF 1730-01

Ø 90 cm
Pack count: 1/7/28

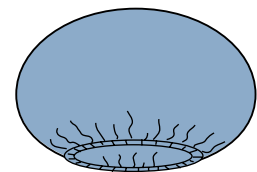

Arm cover

REF 1398-01

Pack count: 1/30/120

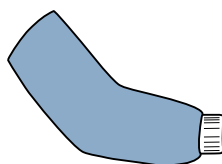

Table covers and components

Leggings

REF 1390-01

75 x 120 cm, 2 pcs/bag
Pack count: 2/18/72



75 x 120 cm
2 pcs

Genital cover

REF 1393

18 x 40 cm
Pack count: 1/55/220

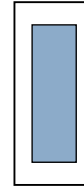

18 x 40 cm

Elastic stockinettes

REF 1395

32 x 120 cm, size L
Pack count: 1/12/48



32 x 120 cm



22 x 75 cm

REF 1396

22 x 75 cm, size S
Pack count: 1/21/84

Fluid collection pouch

REF 1870

30 x 40 cm
Pack count: 1/55/220

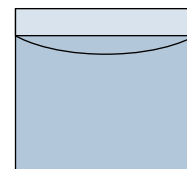

30 x 40 cm

Suction and diathermy bag

REF 1872

30 x 40 cm
Pack count: 1/55/220

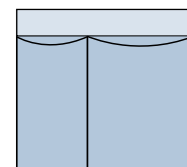

30 x 40 cm

Fluid collection pouch

REF 1873

62 x 50 cm, sieve and outlet
Pack count: 1/11/44

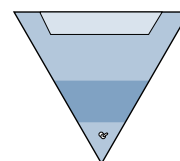

62 x 50 cm

Drapes and sets
Equipment drapes

Tube covers

REF 1810

8 x 120 cm, simple tip
Pack count: 1/65/260

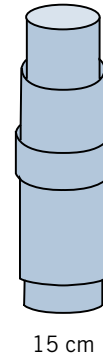
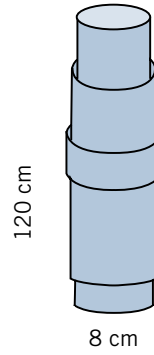

REF 1815

15 x 250 cm, simple tip
Pack count: 1/30/120

REF 1820

15 x 240 cm,
Perforated tip
Pack count: 1/30/120

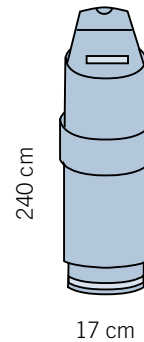
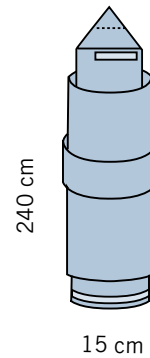

REF 1825

17 x 240 cm,
Elastic tip
Pack count: 1/30/120

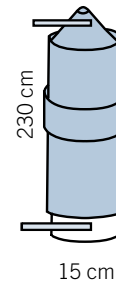

REF 1830

15 x 230 cm, ring insert
Narrow necked simple tip
Pack count: 1/12/48

Banded bags

REF 1850

Ø 90 cm
Pack count: 1/18/72

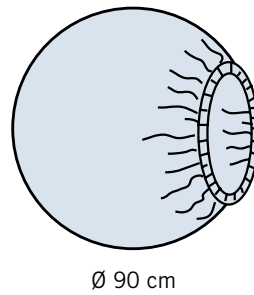

REF 1855

Ø 140 cm
Pack count: 1/12/48

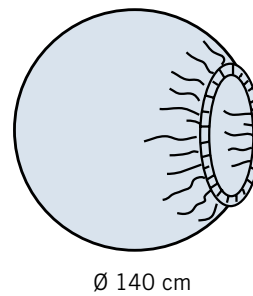

Label information in accordance with EN ISO 15223-1 and EN 1041

evercare® is a registered trademark of OneMed Group Oy



Article number

LOT code in all (4) removable labels

Use before

In all products four (4) removable labels for traceability

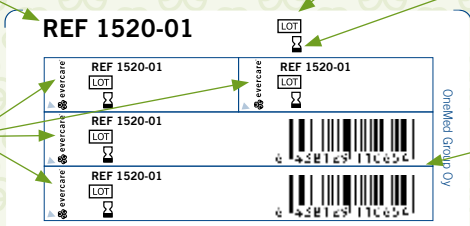

Barcodes in two (2) removable labels

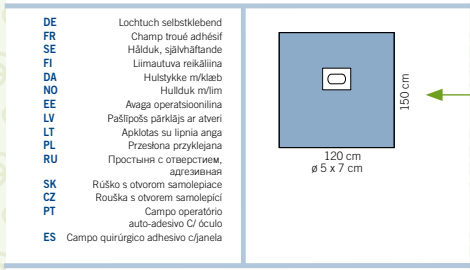

Size

Sterilization method: – ethylene oxide EO



Does not contain natural rubber latex

Single use



CE label: certifies that the product complies with the European legal requirements for medical devices

The identification number of the notified body

Manufacturers contact information

Notes



X-ray detectable
towels, swabs and sponges



evercare® X-ray

X-ray detectable products

XRD GAUZE

Made of EN 14079 cotton gauze evercare® abdominal swabs & laparotomy towels and sponges offer

- a wide range of products
- pvc-free X-ray thread safely woven into the fabric
- heatsealed lint-free easy-to-open wrap
- dispenser boxes for good storage management
- color coding for easy product identification
- numeric control system for counting assistance with following information
 - dry weight of the product
 - number of individual swabs/towels
 - size of the individual swabs/towels
 - number of layers in the product
 - control batch number

More safety with sewing – abdominal swab

- The risk of loose threads much reduced with products sewn so that access to cut edges is prevented

More absorbency with more layers

- all laparotomy towels have 4 layers
- the material used is finest quality 20 thread gauze

More safety with latex-free sponges

- each sponge housed in its individual compartment
- double packed in 2 layers of peel-open pouches

XRD NONWOVEN

Made of EN 1644 nonwoven high quality viscose/polyester evercare® abdominal swabs & laparotomy towels and sponges offer

- high absorbency
- low linting
- cost efficiency
- X-ray thread safely welded to the nonwoven
- abdominal swabs wrapped into a sealed lint-free easy-to-open wrap
- dispenser boxes for good storage management
- latex-free sponges double packed in 2 layers of peel-open pouches
- color coding for easy product identification
- numeric control system for counting assistance contains following information
 - dry weight of the product
 - number of individual swabs/towels
 - size of the individual swabs/towels
 - control batch number



[NATURAL LATEX FREE]

XRD towels, swabs and sponges

Abdominal swabs, X-ray detectable, gauze

REF	Product name	Size, cm	Number of plies	Color code	Pcs/unit pack	Pcs/box	Pcs/ctn
3217	Abdominal swabs, x-ray detectable	10 x 60	4	Lilac	5	120	720
3218	Abdominal swabs, x-ray detectable	10 x 60	8	Green	5	65	390
3219	Abdominal swabs, x-ray detectable	10 x 60	12	Red	5	50	300
3220	Abdominal swabs, x-ray detectable	10 x 10	12	Orange	5	100	600
3213	Abdominal swabs, x-ray detectable, sewn edges	10 x 60	4	Lilac	5	120	720
3214	Abdominal swabs, x-ray detectable, sewn edges	10 x 60	8	Green	5	65	390
3215	Abdominal swabs, x-ray detectable, sewn edges	10 x 60	12	Red	5	50	300
3206	Abdominal swabs, x-ray detectable	10 x 10	12	Orange	5	100	600

Laparotomy towels, X-ray detectable, gauze

REF	Product name	Size, cm	Number of plies	Color code	Pcs/unit pack	Pcs/box	Pcs/ctn
3310	Laparotomy towels, X-ray detectable	30 x 45	4	Brown	5	55	330
3311	Laparotomy towels, X-ray detectable	45 x 70	4	Grey	1	22	132
3312	Laparotomy towels, X-ray detectable	45 x 70	4	Black	5	25	150
3316	Laparotomy towels, X-ray detectable	40 x 45	4	Blue	5	50	300

Surgical sponges, X-ray detectable, gauze

REF	Product name	Size	Color code	Pcs/unit pack	Pcs/box	Pcs/ctn
3101	Surgical sponges, X-ray detectable	0	Orange	5	140	1120
3102	Surgical sponges, X-ray detectable	1	Yellow	5	105	840
3103	Surgical sponges, X-ray detectable	3	Blue	5	90	720
3104	Surgical sponges, X-ray detectable	4	Grey	5	70	560
3105	Surgical sponges, X-ray detectable	5	Black	5	70	560

Surgical swabs, X-ray detectable, nonwoven

REF	Product name	Size, cm	Color code	Pcs/unit pack	Pcs/box	Pcs/ctn
3230	Surgical swabs, X-ray detectable	10 x 40	Orange	5	130	1040
3231	Surgical swabs, X-ray detectable	20 x 40	Green	5	65	520
3232	Surgical swabs, X-ray detectable	30 x 40	Brown	5	45	360
3233	Surgical swabs, X-ray detectable	40 x 65	Grey	1	20	160
3234	Surgical swabs, X-ray detectable	40 x 65	Black	5	20	160

Surgical sponges, X-ray detectable, nonwoven

REF	Product name	Size	Color code	Pcs/unit pack	Pcs/box	Pcs/ctn
3112	Surgical sponges, X-ray detectable	1	Yellow	5	105	840
3113	Surgical sponges, X-ray detectable	3	Blue	5	70	560
3114	Surgical sponges, X-ray detectable	4	Grey	5	50	400
3115	Surgical sponges, X-ray detectable	5	Black	5	50	400

Label information in accordance with EN ISO 15223-1 and EN 1041

evercare® is a registered trademark of OneMed Group Oy

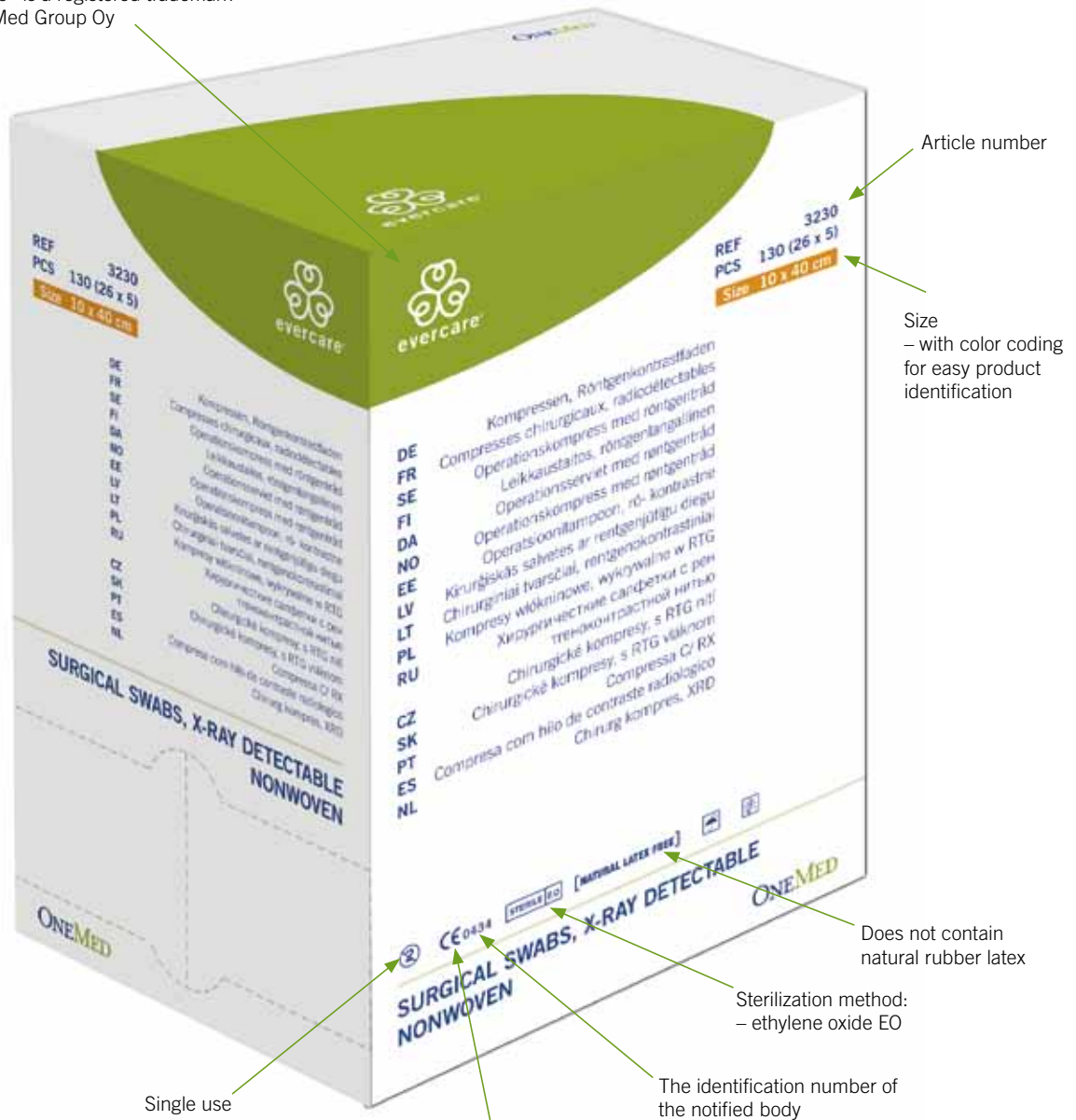

Single use

CE label:
certifies that the product
complies with the European legal
requirements for medical devices

Sterilization method:
- ethylene oxide EO

Does not contain
natural rubber latex

The identification number of
the notified body



Minor
procedure sets



Catheterization sets

Catheterization set, gauze, small

REF 1901

- 1 forceps, green, 127 mm
- 2 large round gauze swabs, diam. 50 mm
- 4 gauze swabs, 8-ply, 7,5 x 7,5cm
- 1 pair X-long nitrile gloves (30 cm), white, size M
- 1 tray, 2-compartment, 182 x 98 x 24 mm
- 1 split sheet 60 x 75 cm
- 1 utility drape (tray wrap) 50 x 50 cm
- Pack count: 1/10/100

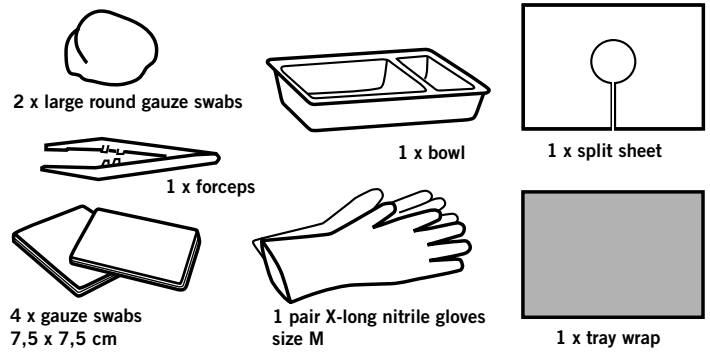

Catheterization set, gauze, large

REF 1941

- 2 forceps, green, 127 mm
- 3 large round gauze swabs, diam. 50 mm
- 5 small round gauze swabs, diam. 30-35 mm
- 5 gauze swabs, 8 ply, 7,5 x 7,5 cm
- 1 kidney bowl 255 x 155 x 44 mm
- 1 small bowl 108 x 84 x 44 mm
- 1 pair X-long nitrile gloves (30 cm), white, size M
- 1 utility drape 60 x 75 cm
- 1 split sheet 60 x 75 cm
- 1 utility drape (tray wrap) 60 x 60 cm
- Pack count: 1 /10/40

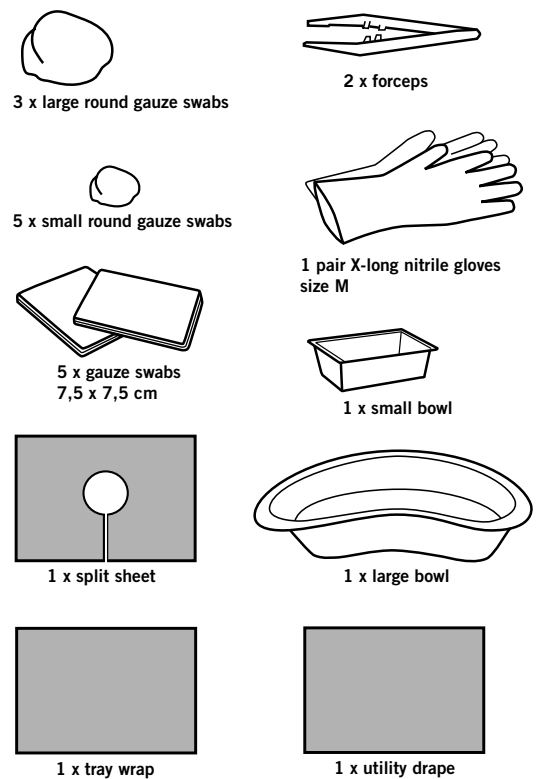

Minor procedure sets
Catheterization sets

Catheterization set, nonwoven, small

REF 1902

- 1 forceps, green, 127 mm
- 2 large round nonwoven swabs, diam. 50 mm
- 4 nonwoven swabs, 8-ply, 7,5 x 7,5cm
- 1 pair X-long nitrile gloves (30 cm), white, size M
- 1 tray, 2-compartment, 182x98x24 mm
- 1 split sheet 60 x 75 cm
- 1 utility drape (tray wrap) 50 x 50 cm
- Pack count: 1/10/100

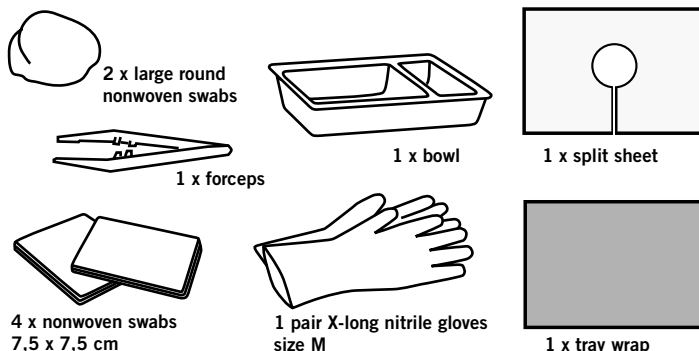

Minor procedure sets

Catheterization set, Large, nonwoven

REF 1942

- 2 forceps, green, 127 mm
- 3 large round nonwoven swabs, diam. 50 mm
- 5 small round nonwoven swabs, diam. 30-35 mm
- 5 nonwoven swabs, 7,5 x 7,5 cm, 8-ply
- 1 kidney bowl 255 x 155 x 44 mm
- 1 small bowl 108 x 84 x 43 mm
- 1 pair X-long nitrile gloves (30 cm), white, size M
- 1 utility drape 60 x 75 cm
- 1 split sheet 60 x 75 cm
- 1 utility drape (tray wrap) 60 x 60 cm
- Pack count: 1/10/40

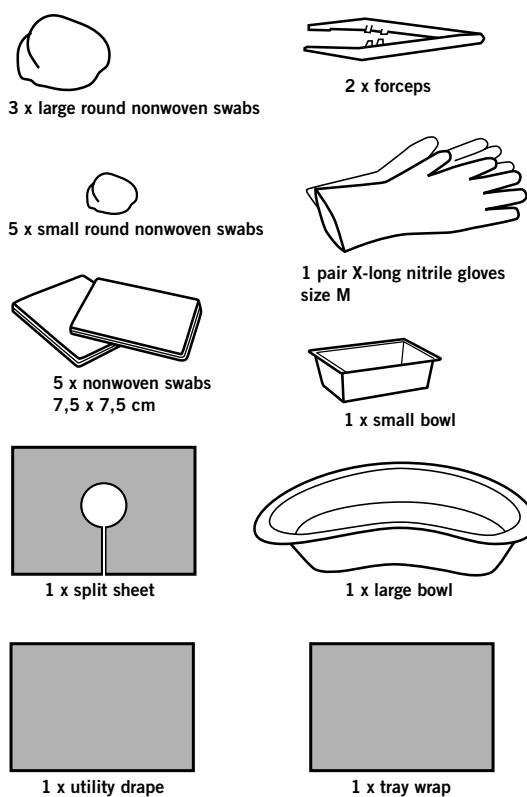

Washing set, gauze

REF 1981

- 10 round gauze swabs diam. 50 mm
- Packed in double pack
- Pack count: 1/20/160



10 x

Washing set, gauze

REF 1982

- 20 round gauze swabs diam. 50 mm
- Packed in double pack
- Pack count: 1/10/60



20 x

Washing set, gauze

REF 1983

- 1 kidney bowl, 255 x 155 x 44mm
- 10 round gauze swabs, diam. 50 mm
- Packed in double pack
- Pack count: 1/10/40



10 x

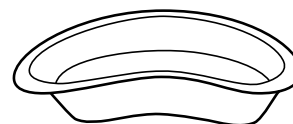

1 x

Washing set, gauze

REF 1984

- 1 kidney bowl , 255 x 155 x 44mm
- 20 round gauze swabs, diam. 50 mm
- Packed in double pack
- Pack count: 1/10/40



20 x



1 x

Washing set, nonwoven

REF 1985

- 10 Round nonwoven swabs, diam. 50 mm
- Packed in double pack
- Pack count: 1/20/160



10 x

Washing set, nonwoven

REF 1986

- 20 round nonwoven swabs, diam. 50 mm
- Packed in double pack
- Pack count: 1/10/60



20 x

Washing set, nonwoven

REF 1987

- 1 kidney bowl, 255 x 155 x 44 mm
- 10 round nonwoven swabs, diam. 50 mm
- Packed in double pack
- Pack count: 1/10/40



10 x

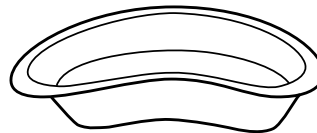

1 x

Washing set, nonwoven

REF 1988

- 1 kidney bowl, 255 x 155 x 44 mm
- 20 round nonwoven swabs, diam. 50 mm
- Packed in double pack
- Pack count: 1/10/40



20 x

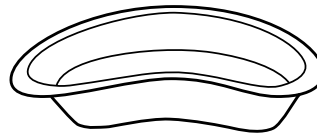

1 x

Washing set, nonwoven

REF 1989

- 1 kidney bowl, blue
- 1 haemostatic forceps, 19 cm
- 10 round nonwoven swabs, diam. 50 mm
- 1 utility drape (tray wrap) 60 x 60 cm
- Packed in double pack
- Pack count: 1/10/40



10 x

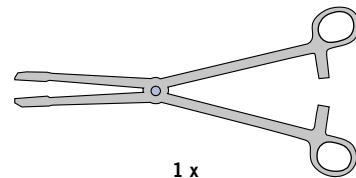

1 x

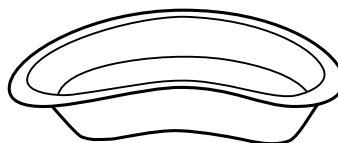

1 x

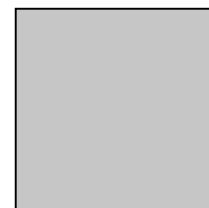

1 x

Dressing set, gauze

REF 1961

- 3 small round gauze swabs, diam. 25 mm
- 2 gauze swabs 5 x 5 cm
- 1 forceps, green, 127 mm
- 1 tray, 4-compartment 148 x 74 x 18 mm
- 1 utility drape (protection cover) 40 x 40 cm
- Pack count: 1/25/200

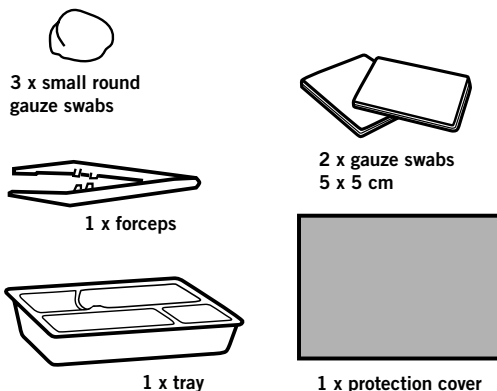

Dressing set, gauze

REF 1962

- 5 small round gauze swabs, diam. 25 mm
- 1 forceps, green, 127 mm
- 1 tray, 4-compartment, 148 x 74 x 18 mm
- 1 utility drape (protection cover) 40 x 40 cm
- Pack count: 1/25/200

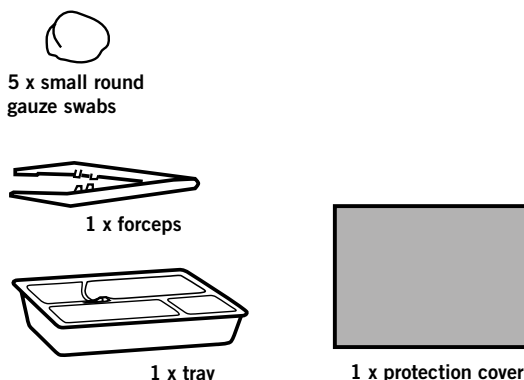

Dressing set, gauze

REF 1963

- 5 small round gauze swabs, diam. 25 mm
- 2 gauze swabs, 8-ply, 5 x 5 cm
- 1 forceps, green, 127 mm
- 1 tray, 4-compartment, 148 x 74 x 18 mm
- 1 utility drape (protection cover) 40 x 40 cm
- Pack count: 1/25/200

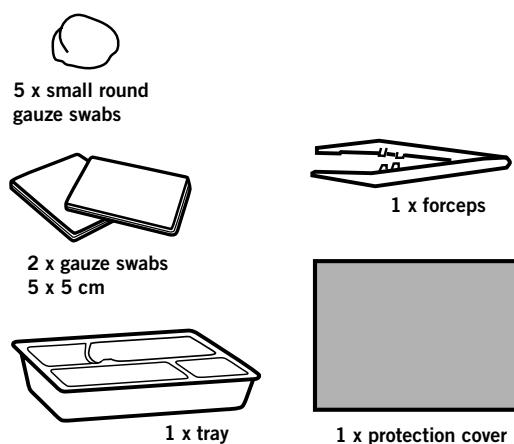

Dressing set, gauze

REF 1964

- 5 round gauze swabs, diam. 25 mm
- 1 forceps, green, 127 mm
- 1 tray, 1-compartment, 152 x 47 x 18 mm
- Pack count: 1/20/320

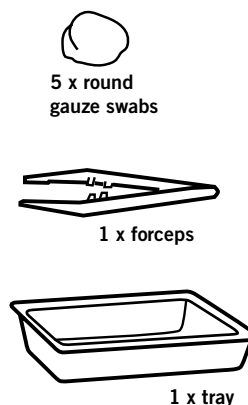

Dressing set, nonwoven

REF 1965

- 3 small round nonwoven round swabs, diam25 mm
- 2 nonwoven swabs, 4-ply, 5 x 5 cm
- 1 forceps, green127 mm
- 1 tray, 4-compartment , 148 x 74 x 18 mm
- 1 utility drape (protection cover) 40 x 40 cm
- Pack count: 1/25/200



3 x small round nonwoven swabs



1 x forceps

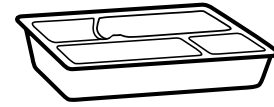

1 x tray



2 x nonwoven swabs
5 x 5 cm



1 x protection cover

Dressing set, nonwoven

REF 1966

- 5 small nonwoven round swabs, diam. 25 mm
- 1 forceps, green127 mm
- 1 tray, 4-compartment, 148x74x18 mm
- 1 utility drape (protection cover) 40x40 cm
- Pack count: 1/25/200



5 x small round nonwoven swabs



1 x forceps

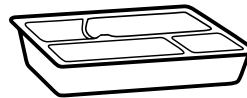

1 x tray



1 x protection cover

Dressing set, nonwoven

REF 1967

- 5 small nonwoven round swabs, diam. 25 mm
- 2 nonwoven swabs. 4-ply, 5 x 5 cm
- 1 forceps, green, 127 mm
- 1 tray, 4-compartment, 148 x 74 x 18mm
- 1 utility drape (protection cover) 40 x 40 cm
- Pack count: 1/25/200



5 x small round nonwoven swabs



1 x forceps



2 x nonwoven swabs
5 x 5 cm

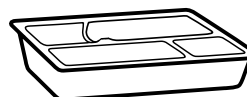

1 x tray



1 x protection cover

Suture removal sets

Suture removal set, gauze

REF 1891

- 1 forceps, 127 mm
- 3 triangular gauze swabs, 30 x 30 x 30 mm
- 1 suture removal knife. packed in peel-open aluminium bag
- 1 tray, white 152 x 47 x 18 mm
- Pack count: 1/20/320

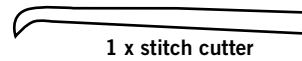

1 x stitch cutter



1 x forceps



3 x gauze swabs

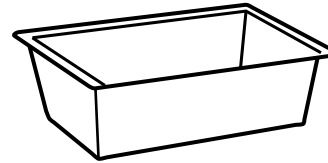

1 x bowl

Suture removal set, nonwoven

REF 1892

- 1 forceps, 127 mm
- 3 triangular nonwoven swabs, 30 x 30 x 30 mm
- 1 suture removal knife. packed in peel-open aluminium bag
- 1 tray, white 152 x 47 x 18 mm
- Pack count: 1/20/320

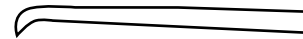

1 x stitch cutter



1 x forceps

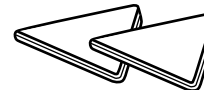

3 x nonwoven swabs

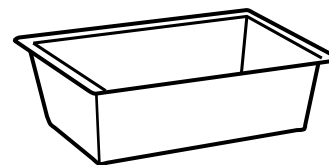

1 x bowl

Notes

Notes

Notes



Surgical gowns



Uncompromising protection – evercare[®] surgical gowns

Comfortably in control with evercare[®] Original surgical gowns

Made of breathable medical fabric which has for decades been considered as industry standard for medical gowns evercare[®] Original provides comfort you feel. The fabric has a soft textile-like structure and features advanced technology: fluid resistant and repellent barrier that breathes.

Highly resistant and repellent SMS-material for evolving needs of medical professionals evercare[®] XP

Our SMS technology utilizes several layers of fabric to provide a very high level of repellency. The fabric features several tightly packed meltblown layers sandwiched between strong spunbond outer layers. An advanced barrier to body fluids and microbes.

Irrespective of the gown material evercare[®] gowns have different protection levels for different needs

- **Basic** – with single back for dry operations of short duration
- **Standard** – with widely overlapping back, the universal gown” for dry operations
- **Special** – with widely overlapping back and breathable film/nonwoven reinforcement in sleeves and front for wet operations, for orthopaedics
- **Extra** – with wide pe-hem for urological procedures





Large size velcro strap at the neck for secure adjustment



Comfortable, user friendly design providing ease of movement



The carefully designed features in both gown types are largely the same

- Comfortable, user friendly design providing ease of movement
- Excellent sizing
- High quality cuffs for improved comfort
- Large size velcro strap at the neck for secure adjustment
- All evercare® gowns meet EN13795
- All evercare® gowns are available with or without hand towels
- State-of-the-art packaging system with handy functional dispenser and labeling in accordance with EN980 and EN1041
- Barcoded removable labels for improved traceability



evercare® Original – spunlace nonwoven

Basic

For dry operations of short duration

REF 2100	130 cm, L, with 2 hand towels	Pack count: 1/18/36
REF 2101	150 cm, XL, with 2 hand towels	Pack count: 1/16/32
REF 2110	130 cm, L, without hand towels	Pack count: 1/18/36
REF 2111	150 cm, XL, without hand towels	Pack count: 1/16/32

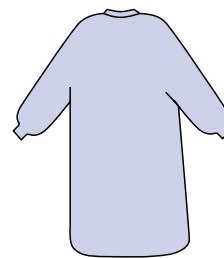

Standard

“Universal” gown, for dry operations

REF 2204	120 cm, M-short, with 2 hand towels	Pack count: 1/18/36
REF 2200	130 cm, M, with 2 hand towels	Pack count: 1/18/36
REF 2201	140 cm, L, with 2 hand towels	Pack count: 1/16/32
REF 2202	150 cm, XL, with 2 hand towels	Pack count: 1/16/32
REF 2203	160 cm, XXL, with 2 hand towels	Pack count: 1/14/28
REF 2214	120 cm, M-short, without hand towels	Pack count: 1/18/36
REF 2210	130 cm, M, without hand towels	Pack count: 1/18/36
REF 2211	140 cm, L, without hand towels	Pack count: 1/16/32
REF 2212	150 cm, XL, without hand towels	Pack count: 1/16/32
REF 2213	160 cm, XXL, without hand towels	Pack count: 1/14/28

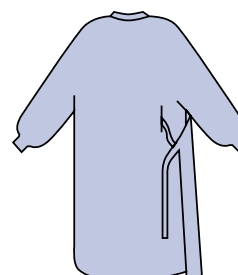

Special

Reinforced, for wet operations, for orthopaedics

REF 2304	120 cm, M-short, with 2 hand towels	Pack count: 1/12/24
REF 2303	130 cm, M, with 2 hand towels	Pack count: 1/12/24
REF 2300	140 cm, L, with 2 hand towels	Pack count: 1/12/24
REF 2301	150 cm, XL, with 2 hand towels	Pack count: 1/12/24
REF 2302	160 cm, XXL, with 2 hand towels	Pack count: 1/14/24
REF 2314	120 cm, M-short, without hand towels	Pack count: 1/14/24
REF 2313	130 cm, M, without hand towels	Pack count: 1/14/24
REF 2310	140 cm, L, without hand towels	Pack count: 1/14/24
REF 2311	150 cm, XL, without hand towels	Pack count: 1/14/24
REF 2312	160 cm, XXL, without hand towels	Pack count: 1/14/24

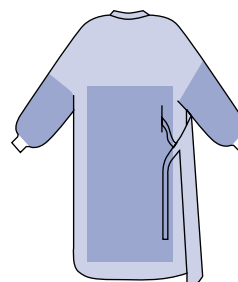

Extra

For urology

REF 2400	156 cm, XL, with 2 hand towels	Pack count: 1/16/32
REF 2410	156 cm, XL, without hand towels	Pack count: 1/16/32

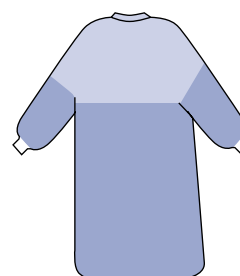

Surgical gowns
evercare® XP – SMS nonwoven

Standard XP	Universal gown, for dry operations	
REF 2504	120 cm, M-short, without hand towels	Pack count: 1/21/42
REF 2505	130 cm, M, without hand towels	Pack count: 1/20/40
REF 2507	140 cm, L, without hand towels	Pack count: 1/20/40
REF 2509	150 cm, XL, without hand towels	Pack count: 1/18/36
REF 2510	160 cm, XXL, without hand towels	Pack count: 1/18/36
REF 2514	120 cm, M-short, with 2 hand towels	Pack count: 1/21/42
REF 2515	130 cm, M, with 2 hand towels	Pack count: 1/20/40
REF 2517	140 cm, L, with 2 hand towels	Pack count: 1/20/40
REF 2519	150 cm, XL, with 2 hand towels	Pack count: 1/18/36
REF 2520	160 cm, XXL, with 2 hand towels	Pack count: 1/18/36

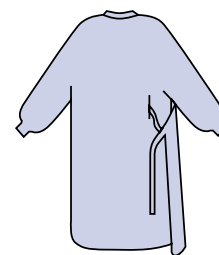

Surgical gowns

Special XP	Reinforced for wet operations, for orthopaedics	
REF 2534	120 cm, M-short, without hand towels	Pack count: 1/21/42
REF 2535	130 cm, M, without hand towels	Pack count: 1/20/40
REF 2537	140 cm, L, without hand towels	Pack count: 1/20/40
REF 2539	150 cm, XL, without hand towels	Pack count: 1/18/36
REF 2540	160 cm, XXL, without hand towels	Pack count: 1/18/36
REF 2544	120 cm, M-short, with 2 hand towels	Pack count: 1/21/42
REF 2545	130 cm, M, with 2 hand towels	Pack count: 1/20/40
REF 2547	140 cm, L, with 2 hand towels	Pack count: 1/20/40
REF 2549	150 cm, XL, with 2 hand towels	Pack count: 1/18/36
REF 2550	160 cm, XXL, with 2 hand towels	Pack count: 1/18/36

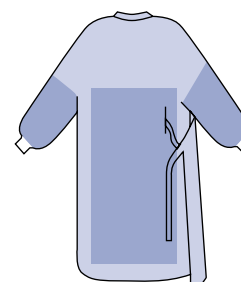

evercare[®] Essentia – SMS nonwoven

Standard	Gown for dry operations	
REF 2521	115 cm, M-short, without hand towels and crepe	Pack count: 2/21/42
REF 2522	126 cm, M, without hand towels and crepe	Pack count: 2/20/40
REF 2523	137 cm, L, without hand towels and crepe	Pack count: 2/20/40
REF 2524	147 cm, XL, without hand towels and crepe	Pack count: 2/18/36
REF 2525	155 XXL, without hand towels and crepe	Pack count: 2/18/36

Standard	Gown for dry operations	
REF 2526	115 cm, M-short, with hand towels and crepe	Pack count: 2/21/42
REF 2527	126 cm, M, with hand towels and crepe	Pack count: 2/20/40
REF 2528	137 cm, L, with hand towels and crepe	Pack count: 2/20/40
REF 2529	147 cm, XL, with hand towels and crepe	Pack count: 2/18/36
REF 2530	155 XXL, with hand towels and crepe	Pack count: 2/18/36

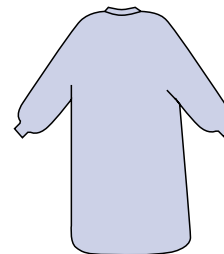

Special	Reinforced gown for dry operations	
REF 2551	115 cm, M-short, without hand towels and crepe	Pack count: 2/21/42
REF 2552	126 cm, M, without hand towels and crepe	Pack count: 2/20/40
REF 2553	137 cm, L, without hand towels and crepe	Pack count: 2/20/40
REF 2554	147 cm, XL, without hand towels and crepe	Pack count: 2/18/36
REF 2555	155 XXL, without hand towels and crepe	Pack count: 2/18/36

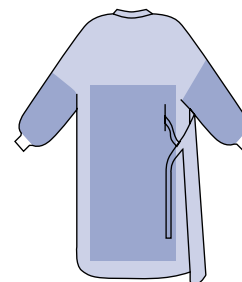

Special	Reinforced gown for wet operations	
REF 2556	115 cm, M-short, with hand towels and crepe	Pack count: 2/21/42
REF 2557	126 cm, M, with hand towels and crepe	Pack count: 2/20/40
REF 2558	137 cm, L, with hand towels and crepe	Pack count: 2/20/40
REF 2559	147 cm, XL, with hand towels and crepe	Pack count: 2/18/36
REF 2560	155 XXL, with hand towels and crepe	Pack count: 2/18/36

Label information in accordance with EN ISO 15223-1 and EN 1041

Surgical gowns

evercare® is a registered trademark of OneMed Group Oy

Article number

Barcode in removable label

LOT code

Sterilization method: – irradiation R

Single use

Size

Use before

Does not contain natural rubber latex

CE label: certifies that the product complies with the European legal requirements for medical devices

The identification number of the notified body

Manufacturers contact information

evercare®

OP-GOWN

evercare® Original STANDARD OP-GOWN

REF 2201
SIZE L
Length 140 cm

REF 2201 SIZE L [LOT]

[LOT]

Do not use if package is damaged.

STERILE R

CE 0434 [NATURAL LATEX FREE]

ONE MED

OneMed Group Oy
Metsäläntie 20, FI-00320 Helsinki, Finland

DE	OP-Mantel
FR	Casaque chirurgicale
SE	OP-rock
FI	Leikkaustakki
DA	Operationskittel
NO	Operasjonsfrakk
EE	Operatsioonikittel
LV	Ķirurgiskais halāts
LT	Chirurginis chalatas
PL	Fartuch operacyjny
RU	Хирургический халат
SK	Operačný plášť
CZ	Operační plášť
PT	Bata cirúrgica
ES	Bata quirúrgica

Notes



Protective apparel



Dressed to care

– evercare[®] protective apparel

The use of protective clothing is an essential element of infection prevention and control. Many items of protective clothing are incorporated within the concept of universal precautions – the precautions necessary to reduce exposure to blood or body fluids. Protective clothing is also used to help prevent the transmission of micro-organisms other than blood-borne viruses – for example, methicillin-resistant *Staphylococcus aureus*, *Staphylococcus aureus* and *Mycobacterium tuberculosis*.

evercare[®] offers a wide selection of single use medical devices for securing the safety and comfort of staff, patients and visitors. A fresh start every time.

Modern scrubs

evercare[®] scrub assortment contains modern medical uniforms consisting of a short-sleeved shirt and pants with and without cuffs in comfortable unisex design and wide selection of sizes. Scrubs also include a waist-length short/medium length or long sleeved jacket with no lapels and stockinette cuffs, a "warm-up jacket". evercare[®] scrub suit shirts and pants complies to the EN standard 13795 for Clean Air Suit. evercare[®] scrubs provide comfort and security of wearing fresh scrubs every day.

Isolation and protective gowns

Different tasks call for different needs of protection. The evercare[®] isolation and protective gown assortment offers solutions from gowns made of different grades of polypropylene to polyethylene coated gowns – for uses ranging from situations with little or no contact with blood or body fluids to where a moderate amount of contact with blood or fluids is anticipated. The anticipated risk of exposure to fluids guides the choice. Choice of high quality raw materials and carefully considered details guarantee that evercare[®] offers the best of protection.



Warm-up jackets

Warm-up jackets, long sleeves

REF 2690

Warm-up jacket with long sleeves, S
Pack count: 1/10/30

REF 2691

Warm-up jacket with long sleeves, M
Pack count: 1/10/30

REF 2692

Warm-up jacket with long sleeves, L
Pack count: 1/10/30

REF 2693

Warm-up jacket with long sleeves, XL
Pack count: 1/10/30



Warm-up jackets, short sleeves

REF 2695

Warm-up jacket with short sleeves, M
Pack count: 1/10/30

REF 2696

Warm-up jacket with short sleeves, L
Pack count: 1/10/30

REF 2697

Warm-up jacket with short sleeves, XL
Pack count: 1/10/30

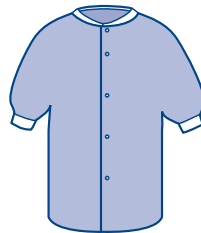

Warm-up jackets, medium sleeves

REF 2685

Warm-up jacket with medium sleeves, M
Pack count: 1/10/30

REF 2686

Warm-up jacket with medium sleeves, L
Pack count: 1/10/30

REF 2687

Warm-up jacket with medium sleeves, XL
Pack count: 1/10/30



Scrub suit Standard

REF 2610

Shirt, S
Pack count: 1/30



REF 2611

Shirt, M
Pack count: 1/30

REF 2612

Shirt, L
Pack count: 1/30

REF 2613

Shirt, XL
Pack count: 1/30

REF 2614

Shirt, XXL
Pack count: 1/30

REF 2616

Pants, S
Pack count: 1/30

REF 2617

Pants, M
Pack count: 1/30

REF 2618

Pants, L
Pack count: 1/30

REF 2619

Pants, XL
Pack count: 1/30

REF 2615

Pants, XXL
Pack count: 1/30

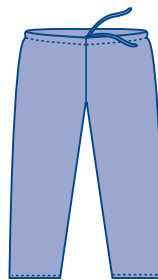

Scrub suit Special (with cuffs)

REF 2620

Shirt, S (with cuffs)
Pack count: 1/130



REF 2621

Shirt, M (with cuffs)
Pack count: 1/30

REF 2622

Shirt, L (with cuffs)
Pack count: 1/30

REF 2623

Shirt, XL (with cuffs)
Pack count: 1/30

REF 2624

Shirt, XXL (with cuffs)
Pack count: 1/30

REF 2626

Pants, S (with cuffs)
Pack count: 1/30

REF 2627

Pants, M (with cuffs)
Pack count: 1/30

REF 2628

Pants, L (with cuffs)
Pack count: 1/30

REF 2629

Pants, XL (with cuffs)
Pack count: 1/30

REF 2630

Pants, XXL (with cuffs)
Pack count: 1/30

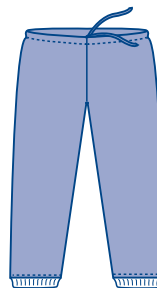

Protective gowns

Protective gown Special, with cuffs

REF 2720

Dark blue, length 125 cm
Pack count: 1/5/25



Protective gowns Extra, with cuffs

REF 2725

Light blue, length 125 cm (L)
Pack count: 50

REF 2728

Light blue, length 145 cm (XL)
Pack count: 50



Impervious isolation gowns, with cuffs (composition: laminate)

REF 2730

Yellow, length 125 cm
Pack count: 50

REF 2731

Blue, length 125 cm
Pack count: 50



Protective gowns

Isolation gowns Special, with knitted cuffs

REF 2733

Yellow, length 115 cm, M
Pack count: 1/5/25

REF 2734

Yellow, length 135 cm, L
Pack count: 1/5/25

REF 2735

Yellow, length 145 cm, XL
Pack count: 1/5/25



Isolation gown, with knitted cuffs

REF 2737

Yellow, length 133 cm
Pack count: 1/10/100

Visitor gowns, nonwoven, with elasticated cuffs

REF 2727

White, length 120 cm
Pack count: 50

REF 2729

Yellow, length 120 cm
Pack count: 50



Protective apparel

Protective gowns

Visitor gown, with velcro

REF 2715

White, length 126 cm, XL
Pack count: 5/25

Visitor gown, with buttons

REF 2712

Dark blue, length 120 cm, L
Pack count: 5/25

REF 2714

Dark blue, length 128 cm, XL
Pack count: 5/25

REF 2716

Dark blue, length 140 cm, XXL
Pack count: 5/25



Protective apparel

Overall with collar

REF 2717

White, L
Pack count: 1/50

REF 2718

White, XL
Pack count: 1/50



Label information in accordance with EN ISO 15223-1 and EN 1041

Protective apparel

evercare® is a registered trademark of OneMed Group Oy

Article number

Single use

LOT code

Use before

evercare®

REF 2733
PCS 5
Size 115 cm M

Colour Yellow

LOT

CE

DE	Schutzkittel	LT	Nepralaidus skysčiams chalatas
FR	Blouse de protection	PL	Fartuch ochronny,nieprzemakalny
SE	Skyddsrock	RU	Халат хирургический непроницаемый
FI	Läpäisemätön suojatakki	SK	Izolačný plášť
DA	Væskeafvisende beskyttelseskittel	CZ	Nepropustný plášť
NO	Beskyttelsesfrakk	PT	Bata de Isolamento
EE	Kaitsekittel, kollane	ES	Bata de aislamiento
LV	Mitrumnecauraidīgi halāti		

ISOLATION GOWN, SPECIAL

[NATURAL LATEX FREE]

ONEMED OneMed Group Oy
 Metsäläntie 20, FI-00320 Helsinki, Finland

6 4381291311327

CE label: certifies that the product complies with the European legal requirements for medical devices

Does not contain natural rubber latex

Manufacturers contact information



Surgical masks and caps



Professional protection by evercare®

Surgical masks are intended to be worn by health care professionals during surgery. They should be worn at other times to catch the bacteria shed in liquid droplets and aerosols from the wearer's mouth and nose.

European Standard EN 14683 specifies the construction and performance requirements, and test methods for surgical masks intended to limit the transmission of infective agents from staff to patients and (in certain situations vice-versa) during surgical procedures in operating theatres and other medical settings with similar requirements.

Key requirements of EN14683

1. Bacterial Filtration Efficiency

Determination of the filtration efficiency of the face mask. The higher the BFE %, the better the protection.

Classification: BFE = ≥ 95 % TYPE I
BFE = ≥ 98 % TYPE II

2. Breathing Resistance

Determination of the airflow resistance of the surgical mask. The lower the differential pressure, the higher the breathing comfort.

Classification: TYPE I & II (non splash resistant) = < 29.4 Pa/cm²
TYPE IR & IIR (splash resistant) = < 49.0 Pa/cm²

3. Splash Resistance

Determination of the resistance of the mask of potentially contaminated fluid splashes.

Classification: TYPE I & TYPE II not applicable
TYPE IR & TYPE IIR >120 mmHg*

*120 mmHg is a minimum value.

It corresponds to the average systolic arterial blood pressure, and intends to protect against ruptures in small arteries causing small sprays of blood.

evercare® surgical mask assortment includes a selection of Type II and Type IIR surgical masks.

evercare® surgical masks complies to the EN14683:2005 for surgical masks.

evercare® surgical masks are soft, comfortable and provide excellent fit.



Surgical masks and caps
Surgical masks



Multiguard

REF 2850

Type II
Tie-band, blue
Pack count: 50/300



Multifix Starline

REF 2855

Type II
Ear-loop, blue
Pack count: 50/300



Multiguard

REF 2851

Type II
Tie-band, green
Pack count: 50/300



Multifix

REF 2856

Type II
Ear-loop, green
Pack count: 50/300



Multiguard Antifog

REF 2865

Type II
Tie-band, antifog, green
Pack count: 50/300



Multifix Guardline

REF 2858

Type II
Ear-loop, green
Pack count: 50/300



Multifix Splash

REF 2875

Type IIR
Ear-loop, splash resistant,
green
Pack count: 50/300



Surgical Mask Duckbill

REF 2852

Type II and Type IIR
Tie-band, splash-resistant, Duckbill, blue/
white
Pack count: 50/300



Surgical Mask

REF 2853

Type IIR
Tie-band, extra wide,
splash-resistant, anti-fog,
soft, white
Pack count: 50/300



Surgical Mask Face shield

REF 2854

Type IIR
Tie-band, visor, anti-fog,
anti-reflection, soft,
splash resistant, blue
Pack count: 25/100



Surgical Mask

REF 2876

Type IIR
Ear-loop, splash resistant, soft, anti-fog, white
Pack count: 50/300

Surgical masks and caps
Surgical hoods



**Surgical hood Gallant,
shoulder protection**

Patterned viscose
nonwoven, latex-free

REF 2779

Green
Pack count: 6 x 50



**Surgical hood Valiant,
shoulder protection**

Patterned viscose
nonwoven, latex-free

REF 2780

Blue
Pack count: 6 x 50



**Surgical hood Lancelot,
neck protection**

Patterned viscose
nonwoven, latex-free

REF 2785

Green
Pack count: 6 x 50



**Surgical hood James,
tie-on**

Patterned viscose nonwoven,
latex-free

REF 2773

Green
Pack count: 6 x 100



REF 2774

Blue
Pack count: 6 x 100

Surgical caps



**Surgical cap
Tricolor**

Patterned viscose nonwoven, soft spunlace sweatband, latex-free

REF 2770

Green/blue/white
Pack count: 6 x 50



**Surgical cap
Romeo**

Patterned viscose nonwoven, latex-free

REF 2788

Green
Pack count: 6 x 100



**Surgical cap
Kolumbus**

Patterned viscose nonwoven, latex-free

REF 2776

Green
Pack count: 6 x 100



**Surgical cap
Tristan, tie-on**

Patterned viscose nonwoven, latex-free

REF 2791

Green
Pack count: 6 x 100



**Surgical cap
Kolumbus**

Patterned viscose nonwoven, latex-free

REF 2777

Blue
Pack count: 6 x 100



**Surgical cap
Tina**

Patterned viscose nonwoven, latex-free

REF 2782

Green
Pack count: 6 x 100



**Surgical cap
Kolumbus**

Patterned viscose nonwoven, latex-free

REF 2778

Violet
Pack count: 6 x 100



**Surgical cap
Tina**

Patterned viscose nonwoven, latex-free

REF 2783

Blue
Pack count: 6 x 100

Surgical caps



Round cap Rondo Standard

Polypropylene nonwoven, latex-free

Pack count: 6 x 150

REF 2740

M (48 cm) Green

REF 2741

M (48 cm) White

REF 2742

M (48 cm) Blue

REF 2743

M (48 cm) Pink

REF 2744

M (48 cm) Multicolor
(Green/Blue/Pink)

REF 2750

L (52 cm) Green

REF 2751

L (52 cm) White

REF 2752

L (52 cm) Blue

REF 2753

L (52 cm) Pink

REF 2754

L (52 cm) Multicolor
(Green/Blue/Pink)

REF 2760

XL (55 cm) Green

REF 2761

XL (55 cm) White

REF 2762

XL (55 cm) Blue

REF 2763

XL (55 cm) Pink

REF 2764

XL (55 cm) Multicolor
(Green/Blue/Pink)



Rondo Special

Polypropylene nonwoven, latex-free

REF 2765

L (52 cm) Blue

Pack count: 6 x 150

Rondo Extra

Polypropylene nonwoven, latex-free

REF 2766

L (52 cm) Blue

Pack count: 6 x 100



Label information in accordance with EN ISO 15223-1 and EN 1041

Surgical masks and caps

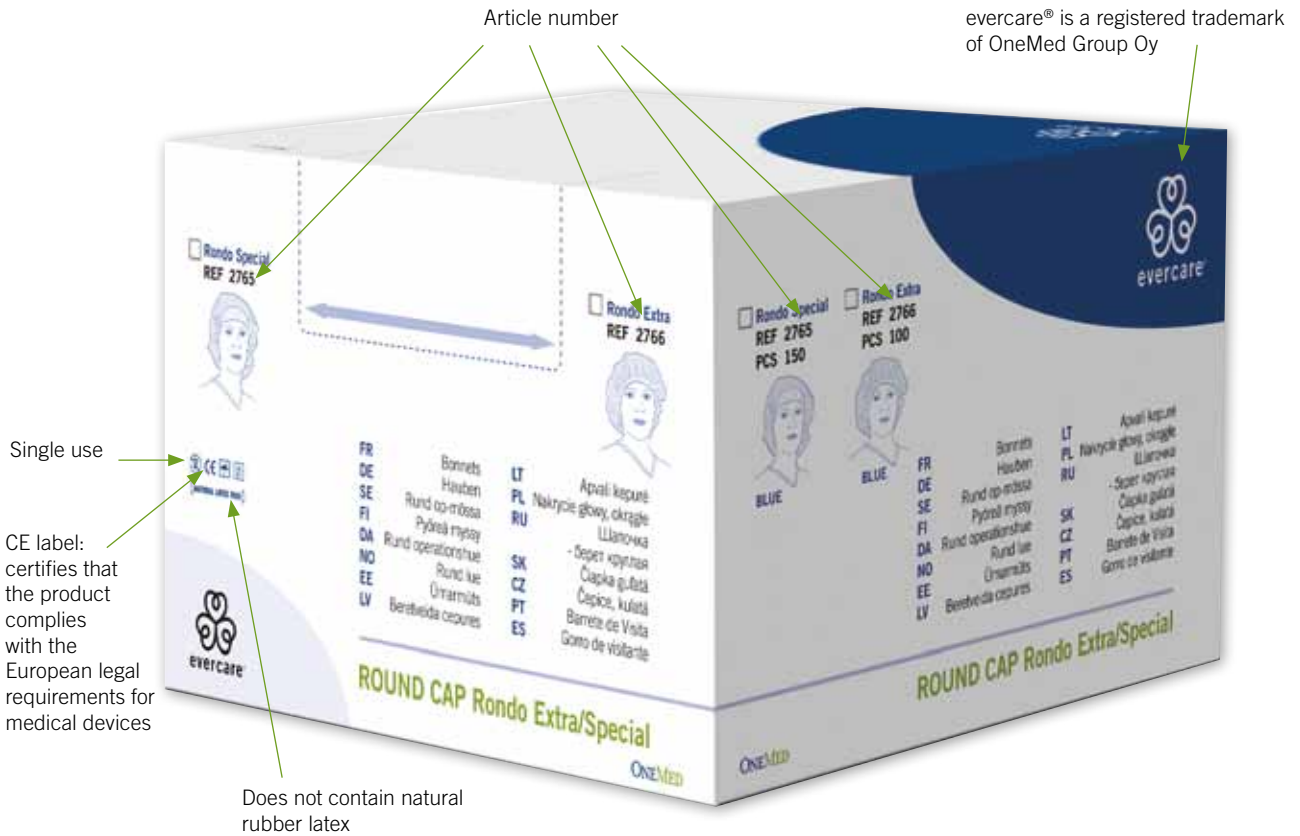



Gloves



Medical gloves

Purpose

- To protect the patient and the professional
- To prevent microbes getting attached to hands and spread of infection via hands
- To protect the hands from
 - Occupational accidents
 - Cleansing agents
 - Chemicals
 - Stick injuries

Choice of glove

Natural rubber latex

- When good protection against microbes is needed
- When the glove is subjected to strong mechanical stress
- When sharp objects are handled
- Long term use

Nitrile

- When good protection against microbes is needed
- Persons suffering from latex allergy
- Casting (glass fibre)
- Handling of cytostatics, chemicals

Vinyl

- When glove is not subjected to hard mechanical stress
- Short term general use

Use of gloves

- Medical gloves are always single-use
- They are used per procedure and per patient
- Depending on the situation either sterile or factory clean gloves are used
- Disposable gloves are neither washed nor disinfected

Use the gloves correctly

- Medical gloves are donned into clean, dry hands
- Hands are disinfected just prior to donning
- After disinfection hands must be allowed to dry before donning
- Hands may get contaminated when undonning the gloves, therefore hands must be disinfected also immediately after undonning
- In all cases involving contaminating materials attention must be paid to correct undonning
- The outer surface of the glove must not get into contact with skin
- When necessary double donning can be applied -> decreased risk of skin contamination while undonning (eg when handling cytostatics)



Contents:

How to use hand disinfectant	71
Vinyl gloves	72
Latex gloves	78
Nitrile gloves	81
Glove box wall dispensers	86
Label information	87
Color coding in sizes	88
Material comparison	89

How to use hand disinfectant

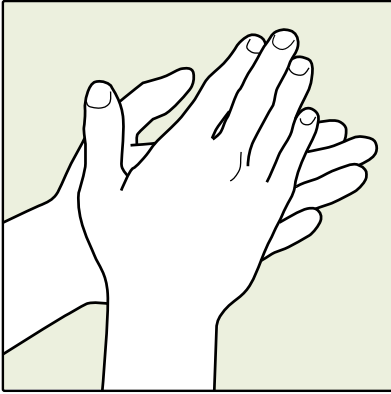

Pour plenty of disinfectant into your cupped hands and start rubbing your palms together.

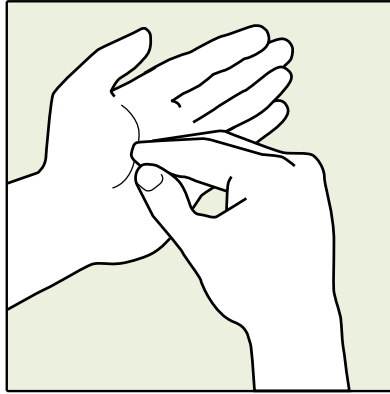

Take more disinfectant. Continue to disinfect fingers and nails and after that...

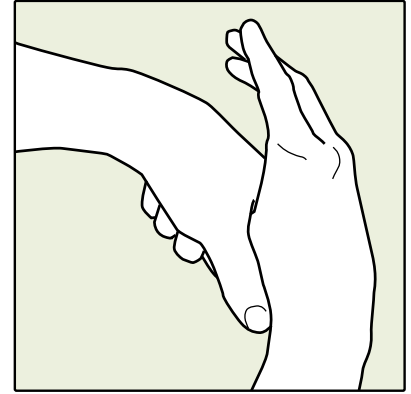

...rub around your right thumb clasped in your left palm and vice versa.

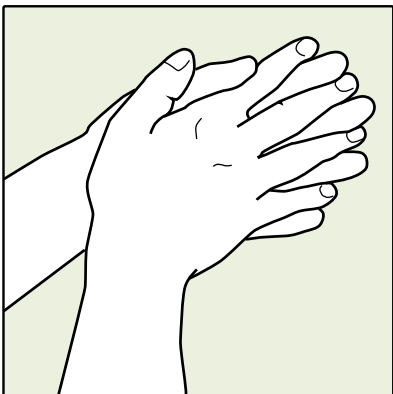

Continue rubbing palm to palm with your fingers interlaced.

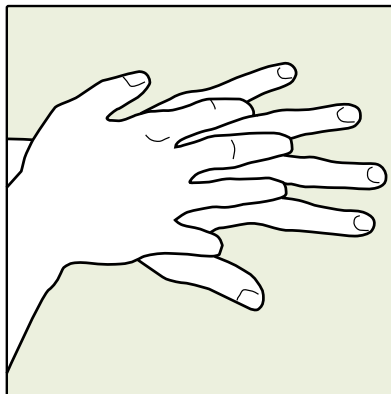

Left palm over back of right hand and right palm over back of left hand.

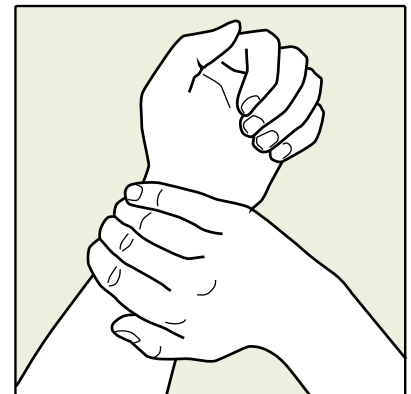

Now disinfect both wrists. Finally let your hands air dry.

Vinyl Soft

Powder-free and powdered evercare® vinyl Soft glove offers practical protection for many applications. The 100 % synthetic glove is somewhat softer than the standard vinyl and has a good feel and performance. It is a good alternative for those suffering from Type I allergies.

Features

- DOP-free
- No latex proteins, good alternative for those suffering from Type I allergies
- Suitable for food handling, except for fatty food
- Available both powder-free and powdered
- Practical barrier for wide range of applications
- Very soft
- Good fit, feel and performance
- AQL 1,5

Quality standards

- Complies with EN 455



Technical information

Type	Powder-free/powdered, unsterile
Material	Vinyl
Colour	Transparent
Model	Ambidextrous, with rolled rim
Storage	Protect from heat, humidity, strong light and ozone
Size/overall length as per EN 455-2	XS, S, M, L and XL 240 mm
Impermeability as per EN 455-1	AQL 1,5
Durability, in original package if stored as per din 7716, ISO 2230	Min. 5 years

Powder-free

REF	Size	Dispenser	Transport carton
6300	XS	100	1000
6301	S	100	1000
6302	M	100	1000
6303	L	100	1000
6304	XL	100	1000

Powdered

REF	Size	Dispenser	Transport carton
6370	XS	100	1000
6371	S	100	1000
6372	M	100	1000
6373	L	100	1000
6374	XL	100	1000

Gloves

Vinyl gloves

Vinyl Extra

Extra strong powder-free vinyl Extra glove offers practical protection for many applications. The glove is 100 % synthetic and has good tactile sense. A very good alternative for those suffering from Type I allergies.



Features

- DOP-free
- Free from latex proteins, good alternative for those suffering from Type I allergies
- Suitable for food handling, except for fatty food
- Practical barrier for wide range of applications
- Very soft and pliable
- Good fit, feel and performance
- AQL 1,5

Quality standards

- Complies with EN 455

Technical information

Type	Powder-free, unsterile
Material	Vinyl
Colour	Transparent
Model	Ambidextrous, with rolled rim
Storage	Protect from heat, humidity, strong light and ozone
Size/overall length as per EN 455-2	XS, S, M, L and XL 240 mm
Impermeability as per EN 455-1	AQL 1,5
Durability, in original package if stored as per din 7716, ISO 2230	Min. 5 years

Powder-free

REF	Size	Dispenser	Transport carton
6330	XS	100	1000
6331	S	100	1000
6332	M	100	1000
6333	L	100	1000
6334	XL	100	1000

Vinyl powder & phthalate-free

evercare® powder- and phthalate-free vinyl is a premium vinyl from both human health and environmental protection point of view. As for food handling these gloves are in conformity with EU Regulation No. 1935/2004. Not suitable for handling fatty foodstuffs.



Features

- Phthalate-free
- A very good general use glove
- No latex proteins, good alternative for those suffering from Type I allergies
- Practical barrier for wide range of applications
- Very soft, good fit, feel and performance
- AQL 1,5

Quality standards

- Complies with EN 455



Technical information

Type	Powder- and phthalate-free, unsterile
Material	Vinyl
Colour	Transparent
Model	Ambidextrous, with rolled rim
Storage	Protect from heat, humidity, strong light and ozone
Size/overall length as per EN 455-2	XS, S, M, L and XL 240 mm
Impermeability as per EN 455-1	AQL 1,5
Durability, in original package if stored as per din 7716, ISO 2230	Min. 5 years

Powder- & phthalate-free

REF	Size	Dispenser	Transport carton
6350	XS	100	1000
6351	S	100	1000
6352	M	100	1000
6353	L	100	1000
6354	XL	100	1000

Powder- & phthalate-free consumer

REF	Size	Dispenser	Transport carton
6357	M	10	480
6358	L	10	480

Gloves

Vinyl gloves

Vinyl powder & phthalate-free X-long

A comfortable X-long all-purpose vinyl glove without harmful phthalates. Offers the same performance as regular vinyl glove.



Features

- Free of phthalates and natural rubber, good alternative for those suffering from Type I allergies
- General use X-long glove
- X-long for added protection
- AQL 1,5

Quality standard

- Complies with EN 455

Technical information

Type	Powder- and phthalate-free, unsterile
Material	Vinyl
Colour	Transparent
Model	Ambidextrous, with rolled rim
Storage	Protect from heat, humidity, strong light and ozone
Size/overall length as per EN 455-2	XS, S, M, L and XL 285 mm
Impermeability as per EN 455-1	AQL 1,5
Durability, in original package if stored as per din 7716, ISO 2230	Min. 5 years

Powder- & phthalate-free

REF	Size	Dispenser	Transport carton
6305	XS	100	1000
6306	S	100	1000
6307	M	100	1000
6308	L	100	1000
6309	XL	100	1000

Vinyl gloves

Vinyl Stretch

Stretchy, natural white, latex free gloves have a more comfortable fit than standard vinyl gloves. They offer enhanced tactile sensitivity and a practical barrier of protection for a wide range of applications. They are also a good alternative for those suffering from Type I allergies.



Features

- DOP-free
- No latex proteins, low allergenicity potential
- Suitable for food handling except for fatty food
- Comfortable conforming latexlike fit
- Effective barrier and extra strength
- Enhanced tactile sensitivity
- Same colour as latex
- Economical protection
- AQL 1,5

Quality standards

- Complies with EN 455

Technical information

Type	Powder-free, unsterile
Material	Vinyl
Colour	Natural white
Model	Ambidextrous, with rolled rim
Storage	Protect from heat, humidity, strong light and ozone
Size/overall length as per EN 455-2	XS, S, M, L and XL 240 mm
Impermeability as per EN 455-1	AQL 1,5
Durability, in original package if stored as per din 7716, ISO 2230	Min. 5 years

Stretch

REF	Size	Dispenser	Transport carton
6325	XS	100	1000
6326	S	100	1000
6327	M	100	1000
6328	L	100	1000
6329	XL	100	1000

Gloves

Vinyl gloves

Vinyl X-long

Powder-free evercare® vinyl offers practical protection for many applications. The 100 % synthetic glove is soft and has a good feel and performance. It is a good alternative for those suffering from Type I allergies.



Features

- DOP-free
- No latex proteins, low allergenicity potential
- Suitable for food handling except for fatty food
- Comfortable conforming latexlike fit
- Effective barrier and extra strength
- Enhanced tactile sensitivity
- Same colour as latex
- Economical protection
- AQL 1,5

Quality standards

- Complies with EN 455

Technical information

Type	Powder-free, unsterile
Material	Vinyl
Colour	Natural white
Model	Ambidextrous, with rolled rim
Storage	Protect from heat, humidity, strong light and ozone
Size/overall length as per EN 455-2	XS, S, M, L and XL 280 mm
Impermeability as per EN 455-1	AQL 1,5
Durability, in original package if stored as per din 7716, ISO 2230	Min. 5 years

X-long

REF	Size	Dispenser	Transport carton
6320	XS	100	1000
6321	S	100	1000
6322	M	100	1000
6323	L	100	1000
6324	XL	100	1000

Latex gloves

Latex inner coated

Latex Powder-free examination gloves offer ultimate comfort and protection, a perfect combination of strength, elasticity and slip resistance. Because of their thickness and elasticity they perform well in high-risk, heavy-duty situations. They fit comfortably like a second skin. The only downside to natural rubber latex examination gloves is that being a protein based compound they may cause allergic reactions and irritation in some people – including anaphylactic reaction.

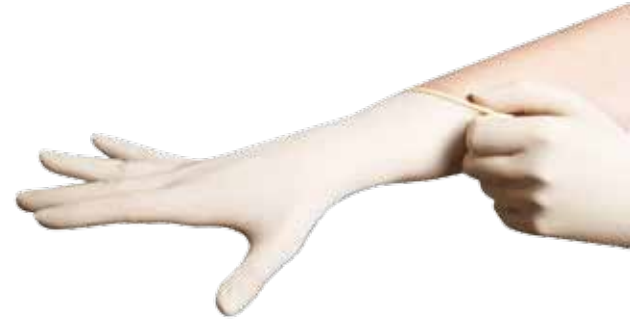

Features

- Beaded cuff for easy donning and prevention of roll back
- Excellent and tactile sense
- Textured for improved grip
- Powder-free glove inner coated
- Low level of extractable proteins and chemical residue
- Food safe, suitable for handling foodstuffs
- AQL 1,5



Quality standards

- Complies with EN 455

Technical information

Type	Powder-free, unsterile
Material	Latex
Colour	Natural white
Model	Ambidextrous, with rolled rim
Storage	Protect from heat, humidity, strong light and ozone
Size/overall length as per EN 455-2	XS, S, M, L and XL 240 mm
Impermeability as per EN 455-1	AQL 1,5
Durability, in original package if stored as per din 7716, ISO 2230	Min. 5 years

Inner coated

REF	Size	Dispenser	Transport carton
6200	XS	100	1000
6201	S	100	1000
6202	M	100	1000
6203	L	100	1000
6204	XL	100	1000

Latex gloves

Latex X-long, textured

Latex powder-free examination glove for comfort and protection. An X-long glove with good strength and elasticity. Good performance also in high-risk situation. Fits comfortably like a second skin. The only downside to natural rubber latex examination gloves is that being a protein based compound they may cause allergic reactions and irritation in some people – including anaphylactic reaction.



Features

- Beaded cuff for easy donning and prevention of roll back
- Available both Powder-free and powdered
- Powder-free glove inner coated
- Low level of extractable proteins and chemical residue
- Food safe, suitable for handling foodstuffs
- AQL 1,5

Quality standards

- Complies with EN 455



Technical information

Type	Powder-free, unsterile
Material	Latex
Colour	Natural white
Model	Ambidextrous, with rolled rim
Storage	Protect from heat, humidity, strong light and ozone
Size/overall length as per EN 455-2	XS, S, M, L and XL 290 mm
Impermeability as per EN 455-1	AQL 1,5
Durability, in original package if stored as per din 7716, ISO 2230	Min. 5 years

Textured

REF	Size	Dispenser	Transport carton
6220	XS	100	1000
6221	S	100	1000
6222	M	100	1000
6223	L	100	1000
6224	XL	100	1000

Latex, smooth and textured

Latex powdered examination gloves offer comfort and protection, a perfect combination of strength and elasticity. They perform well in high-risk, heavy-duty situations. They fit comfortably like a second skin. The only downside to natural rubber latex examination gloves is that being a protein based compound they may cause allergic reactions and irritation in some people – including anaphylactic reaction.

Features

- Beaded cuff for easy donning and prevention of roll back
- Available both powder-free and powdered
- Low level of extractable proteins and chemical residue
- Food safe, suitable for handling foodstuffs
- AQL 1,5

Quality standards

- Complies with EN 455



Technical information

Type	Powdered, unsterile
Material	Latex
Colour	Natural white
Model	Ambidextrous, with rolled rim
Storage	Protect from heat, humidity, strong light and ozone
Size/overall length as per EN 455-2	XS, S, M, L and XL 240 mm
Impermeability as per EN 455-1	AQL 1,5
Durability, in original package if stored as per din 7716, ISO 2230	Min. 5 years

Smooth

REF	Size	Dispenser	Transport carton
6270	XS	100	1000
6271	S	100	1000
6272	M	100	1000
6273	L	100	1000
6274	XL	100	1000

Textured

REF	Size	Dispenser	Transport carton
6280	XS	100	1000
6281	S	100	1000
6282	M	100	1000
6283	L	100	1000
6284	XL	100	1000

Gloves

Nitrile gloves

Nitrile heavy duty, blue and X-long blue

On the market already for a long time nitrile gloves now have a new formula for increased softness and comfort and are even more closer to latex gloves in stretch, tactile sensitivity and performance. They are recommended for use in areas that may involve levels of stress.



Features

- 100% latex free – made from durable nitrile, eliminates the Type 1 allergic reaction associated with natural rubber
- Close to latex in stretch, tactile sensitivity and performance
- Designed to give a natural rubber-like feel
- Textured in finger tips for excellent grip in all situations
- Food safe, suitable for handling fatty foods incl. cooking, olive and cod liver oil
- AQL 1,0

Quality standards

- Complies with EN 455 and EN 374



Technical information

Type	Powder-free, unsterile
Material	Nitrile butadiene rubber (NBR)
Colour	Blue
Model	Ambidextrous, with rolled rim
Storage	Protect from heat, humidity, strong light and ozone
Size/overall length as per EN 455-2	XS, S, M, L and XL 240/290 mm
Impermeability as per EN 455-1	AQL 1,0
Durability in original package if stored as per din 7716, ISO 2230	5 years

Blue

REF	Size	Dispenser	Transport carton
6400	XS	100	1000
6401	S	100	1000
6402	M	100	1000
6403	L	100	1000
6404	XL	100	1000

X-long blue

REF	Size	Dispenser	Transport carton
6420	XS	100	1000
6421	S	100	1000
6422	M	100	1000
6423	L	100	1000
6424	XL	100	1000

Nitrile gloves

Nitrile, accelerator-free blue and X-long blue

Synthetic accelerator-free nitrile glove is an excellent alternative for those suffering from type I and type IV allergies. Made of synthetic latex it offers a resistant barrier of protection for a wide range of applications.

Features

- 100% latex- and accelerator-free – made from durable nitrile, eliminates the Type 1 and Type IV allergic reaction associated with natural rubber
- Close to latex in stretch, tactile sensitivity and performance
- Designed to give a natural rubber-like feel
- Textured in finger tips for better grip in all situations
- Food safe, suitable for handling fatty foods including cooking, olive and cod liver oil
- Protects against a wide variety of chemicals
- AQL 1,0

Quality standards

- Complies with EN 455 and EN 374



Technical information

Type	Powder-free, unsterile
Material	Nitrile butadiene rubber (NBR)
Colour	Blue
Model	Ambidextrous, with rolled rim
Storage	Protect from heat, humidity, strong light and ozone
Size/overall length as per EN 455-2	XS, S, M, L and XL 240/300 mm
Impermeability as per EN 455-1	AQL 1,0
Durability in original package if stored as per din 7716, ISO 2230	5 years

Blue

REF	Size	Dispenser	Transport carton
6460	XS	150	1500
6461	S	150	1500
6462	M	150	1500
6463	L	150	1500
6464	XL	150	1500

X-long blue

REF	Size	Dispenser	Transport carton
6465	XS	100	1000
6466	S	100	1000
6467	M	100	1000
6468	L	100	1000
6469	XL	100	1000

Gloves

Nitrile gloves

Nitrile general use: rose, blue lilac and white

Comfortable, supersoft flexible powderfree nitrile gloves provide added safety in many applications. Designed with a special nitrile formulation they feel and fit like latex and allow full range of motion and excellent flexibility to minimise stress and fatigue. They do not contain natural rubber latex and are excellent alternative for those suffering from Type I allergies.

Features

- 100% latex free – made from durable, puncture resistant, protein and powder-free nitrile, eliminates the Type 1 allergic reaction associated with natural rubber latex
- Highly elastic and supersoft
- Rolled rim to facilitate easy donning
- Designed to give a natural rubber-like feel
- Textured in finger tips for enhanced grip in all situations
- Food safe, suitable for handling fatty foods incl. cooking, olive and cod liver oil
- Protects against a wide variety of chemicals
- AQL 1.0

Quality standards

- Complies with EN 455 and EN 374

Technical information

Type	Powder-free, unsterile
Material	Nitrile butadiene rubber (NBR)
Colour	Rose/blue lilac/grey/white/black
Model	Ambidextrous, with rolled rim
Storage	Protect from heat, humidity, strong light and ozone
Size/overall length as per EN 455-2	XS, S, M, L and XL 240 mm
Impermeability as per EN 455-1	AQL 1,0
Durability, in original package if stored as per din 7716, ISO 2230	5 years



Rose

REF	Size	Dispenser	Transport carton
6410	XS	150	1500
6411	S	150	1500
6412	M	150	1500
6413	L	150	1500
6414	XL	150	1500

Blue lilac

REF	Size	Dispenser	Transport carton
6415	XS	150	1500
6416	S	150	1500
6417	M	150	1500
6418	L	150	1500
6419	XL	150	1500

White

REF	Size	Dispenser	Transport carton
6425	XS	150	1500
6426	S	150	1500
6427	M	150	1500
6428	L	150	1500
6429	XL	150	1500

Nitrile gloves

Nitrile general use: grey and black

Comfortable, supersoft flexible powderfree nitrile gloves provide added safety in many applications. Designed with a special nitrile formulation they feel and fit like latex and allow full range of motion and excellent flexibility to minimise stress and fatigue. They do not contain natural rubber latex and are excellent alternative for those suffering from Type I allergies.

Features

- 100% latex free – made from durable, puncture resistant, protein and powder-free nitrile, eliminates the Type 1 allergic reaction associated with natural rubber latex
- Highly elastic and supersoft
- Rolled rim to facilitate easy donning
- Designed to give a natural rubber-like feel
- Textured in finger tips for enhanced grip in all situations
- Food safe, suitable for handling fatty foods incl. cooking, olive and cod liver oil
- Protects against a wide variety of chemicals
- AQL 1.0

Quality standards

- Complies with EN 455 and EN 374

Technical information

Type	Powder-free, unsterile
Material	Nitrile butadiene rubber (NBR)
Colour	Grey/black
Model	Ambidextrous, with rolled rim
Storage	Protect from heat, humidity, strong light and ozone
Size/overall length as per EN 455-2	XS, S, M, L and XL 240 mm
Impermeability as per EN 455-1	AQL 1,0
Durability, in original package if stored as per din 7716, ISO 2230	5 years

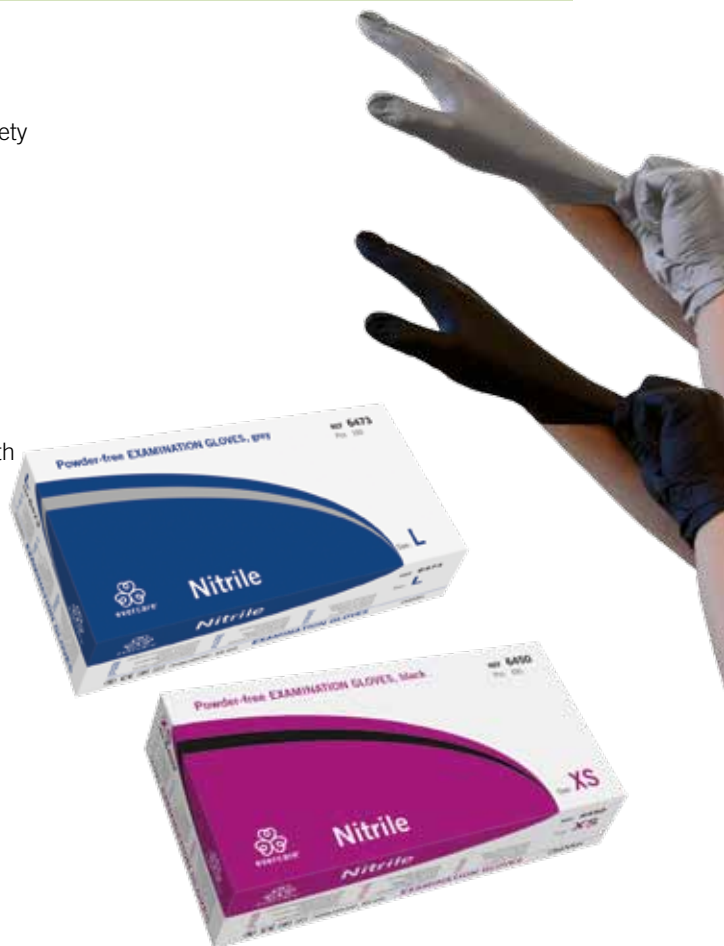

Grey

REF	Size	Dispenser	Transport carton
6470	XS	150	1500
6471	S	150	1500
6472	M	150	1500
6473	L	150	1500
6474	XL	150	1500

Black

REF	Size	Dispenser	Transport carton
6450	XS	150	1500
6451	S	150	1500
6452	M	150	1500
6453	L	150	1500
6454	XL	150	1500

Gloves

Nitrile gloves

Nitrile textured white

Comfortable, flexible powderfree nitrile gloves provide added safety in high-risk applications. Designed with a special nitrile formulation they feel and fit like latex and allow full range of motion and excellent flexibility to minimise stress and fatigue. They do not contain natural rubber latex and are excellent alternative for those suffering from Type I allergies.

Features

- Highly elastic
- Rolled rim to facilitate easy donning
- Excellent alternative for those suffering from latex allergy
- Fully textured, excellent grip in all situations
- Best possible protection
- Food safe, suitable for handling fatty foods incl. cooking, olive and cod liver oil
- AQL 1.0

Quality standards

- Complies with EN 455 and EN 374



Technical information

Type	Powder-free, unsterile
Material	Nitrile butadiene rubber (NBR)
Colour	White
Model	Ambidextrous, with rolled rim
Storage	Protect from heat, humidity, strong light and ozone
Size/overall length as per EN 455-2	XS, S, M, L and XL 240 mm
Impermeability as per EN 455-1	AQL 1,0
Durability, in original package if stored as per din 7716, ISO 2230	5 years

White

REF	Size	Dispenser	Transport carton
6430	XS	100	1000
6431	S	100	1000
6432	M	100	1000
6433	L	100	1000
6434	XL	100	1000

Glove box wall dispensers

evercare® glove box wall dispenser

Acrylic glove box dispenser for 1, 2 or 3 boxes of examination gloves (100 pcs/box or 150 pcs/box) of evercare® latex, vinyl and nitrile gloves

REF	Description	Suited for pcs of boxes	Unit pack	Transport carton
5251	Unismart mini	1 box	1 pcs	1 x 10
5252	Unismart medi	2 boxes	1 pcs	1 x 10
5253	Unismart maxi	3 boxes	1 pcs	1 x 10



Cleaning: Mild soap solution and water or alternatively 70 % ethanol or similar.

Label information in accordance with EN ISO 15223-1 and EN 1041

evercare® is a registered trademark of OneMed Group Oy



Article number

Size

Does not contain natural rubber latex

Single use

CE label: certifies that the product complies with the European legal requirements for medical devices

Gloves

The bottom of the box:

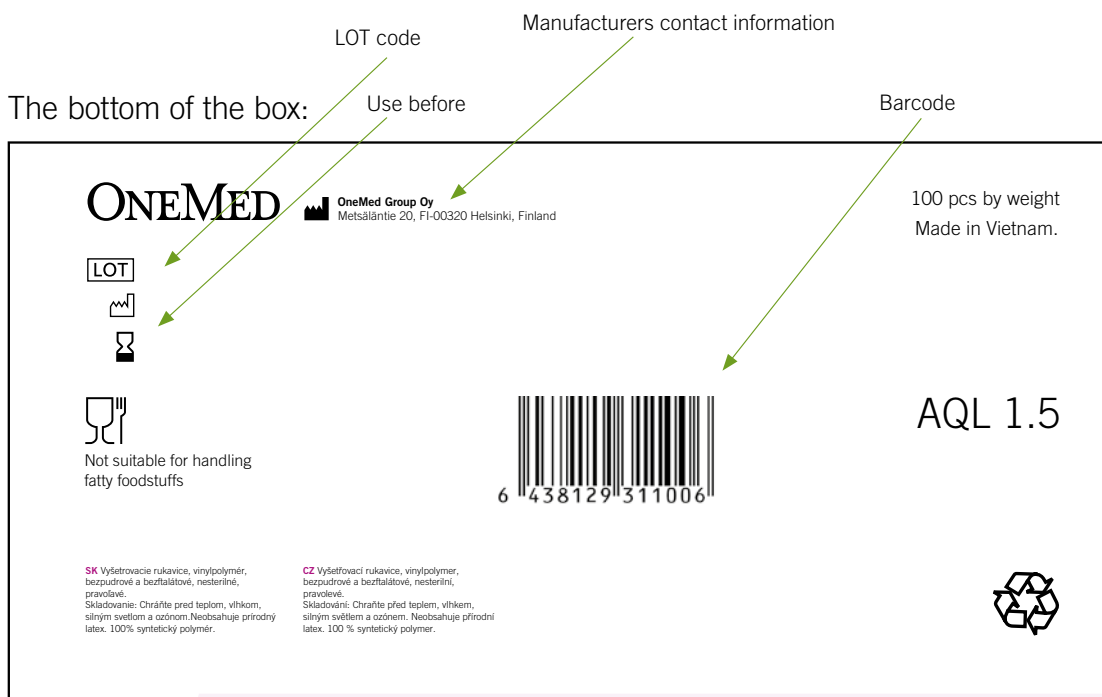

LOT code

Manufacturers contact information

Use before

Barcode

100 pcs by weight
Made in Vietnam.

AQL 1.5

Not suitable for handling fatty foodstuffs

SK Vyšetřovací rukavice, vinylpolymer, bezprstové a bezčlankové, nesterilní, pravolevé.
Skladování: Chraňte před teplem, vlhkem, slunečním světlem a ozónem. Neobsahuje přírodní latex. 100% syntetický polymer.

CZ Vyšetřovací rukavice, vinylpolymer, bezprstové a bezčlankové, nesterilní, pravolevé.
Skladování: Chraňte před teplem, vlhkem, slunečním světlem a ozónem. Neobsahuje přírodní latex. 100 % syntetický polymer.



Color coding in sizes

Glove boxes colour coded for easy size identification

XS	=	
S	=	
M	=	
L	=	
XL	=	



Material comparison

	Vinyl	Latex	Nitrile
Material	Polyvinyl chloride, a synthetic polymer	Natural rubber latex from the rubber tree <i>Hevea brasiliensis</i>	Acrylonitrile butadiene, synthetic latex
Protection	Vinyl gives moderate protection due to limited strength and chemical resistance.	Due to strength, elasticity and chemical resistance latex gives very reliable and effective protection	Nitrile is strong, elastic and resistant to a wider range of chemicals than vinyl or latex. It offers excellent protection
Strength	Limited. Minimum force at break 3,6 N as per EN455:2	Superior. Minimum force at break requirement 9 N as per EN455:2	Excellent strength and puncture resistance. Minimum force at break requirement 6 N as per EN455:2
Elasticity	Low to medium. Moderate flexibility	High level of elasticity, memory and elongation	Medium to high, conforms to hand during use.
Durability	Moderate	Highly resistant to tears	Highly resistant to punctures and tears. If punctured tear easily detectable
Chemical resistance	Resistant to acids, bases and common alcohols	Good to excellent for a number of chemicals, not recommended for use with oils	Good to excellent with a number of common chemicals. EN374 compliance becoming more and more common
Chemotherapy use	Not recommended	Normal examination glove not recommended	Heavy duty nitrile recommended
Compatibility with lotions	Water and glyserine based only	Water and glyserine based only	Water and glyserine based only
Possible glove related reactions	Irritant Contact Dermatitis Chemical allergies (Type IV)	Irritant Contact Dermatitis Chemical allergies (Type IV) Latex protein allergies (Type I)	Irritant Contact Dermatitis Chemical allergies (Type IV)
Glove powder	May cause a wide variety of reactions for patients and staff	May cause a wide variety of reactions for patients and staff	May cause a wide variety of reactions for patients and staff
Fit and comfort	Good, conforms to hand	Excellent, conforms to hand	Excellent, conforms to hand



Gloves

Notes

Gloves

Gloves
Notes

Gloves

Notes

Gloves



Professional wound care
by evercare[®]



Adhesive fabrics

evercare® self adhesive fabrics, roll

For fixation of dressings, swabs, catheters and cannulae

- Gentle but secure fixation
- Ideal for areas such as neck, elbows & knee

Easy to remove release paper

- Premeasured in 1 cm intervals
- Perforated split for easy removal and application

Breathable

- Pleasant to wear
- Prevents maceration

Skin-friendly adhesive

Stretchable, conforms well to body contours, allows movement when in place

Moisture repellent

- barrier for blood and fluid strike through

Non-sterile



4560



Self adhesive fabric, roll

REF	Size cm x m	Pcs/box	Pcs/carton
4555	2,5 x 10	1 roll	120
4560	5 x 10	1 roll	60
4565	10 x 10	1 roll	36
4570	15 x 10	1 roll	24
4575	20 x 10	1 roll	18
4580	30 x 10	1 roll	12

Wound care

Sterile forceps

evercare® forceps, sterile

REF 1899

1 pc/bag

50 pcs/dispenser

300 pcs/transport carton

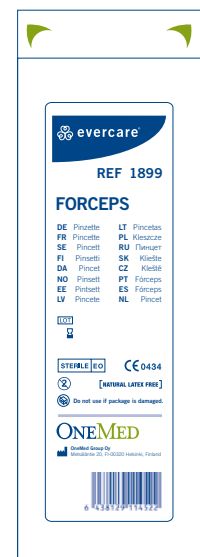

Adhesive dressings

evercare® adhesive surgical dressing

Permeable adhesive dressing for low to moderately exuding wounds

Soft, elastic repellent nonwoven

- High breathability
- Improved patient comfort

Easy-to-remove release paper for aseptic application

Rounded corners for secure fixation

Absorbent wound pad with low-adherent contact layer

- Comfort, minimises risk of adherence to wound
- Longer wear time

Skin-friendly adhesive

Air permeable

- Pleasant to wear
- Prevents maceration

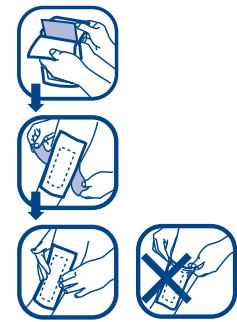
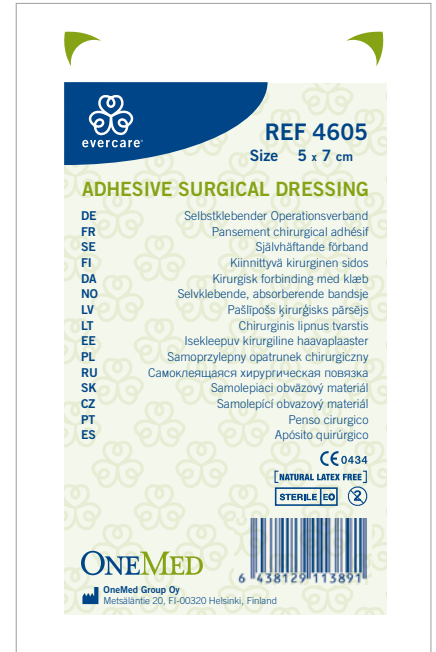

Adhesive surgical dressing

REF	Size cm	Pad size cm	Pcs/box	Pcs/carton
4605	5 x 7	2,5 x 4	50	2400
4610	10 x 10	5 x 5	50	1200
4615	10 x 15	5 x 11	50	600
4620	10 x 20	5 x 15,5	30	360
4625	10 x 25	5 x 20	30	360
4630	10 x 30	5 x 25	30	360
4635	10 x 35	5 x 30	30	360

Adhesive IV dressing

REF	Size cm	Pad size cm	Pcs/box	Pcs/carton
4640	8 x 6	1,3 x 2,4 loose 1,5 x 3	50	2400

Self-adhesive plasters, roll

REF	Size cm x m	Pad width	Pcs/box	Pcs/carton
4645	4 cm x 5 m	1,8 cm	1	32
4646	8 cm x 5 m	4 cm	1	32

Adhesive film dressings

evercare® absorbent shower proof adhesive dressing

Adhesive absorbent and breathable dressing that protects from water and contamination

Allows showering

Other features as in evercare® adhesive surgical dressing

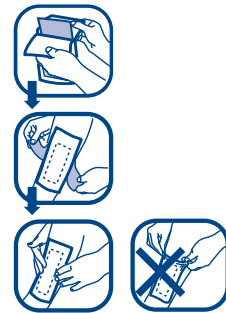

4660



Absorbent shower proof adhesive dressing

REF	Size cm	Pad size cm	Pcs/box	Pcs/carton
4655	5 x 7,2	2,5 x 4	50	2400
4660	10 x 10	4,5 x 4,5	50	1200
4665	10 x 15	5,2 x 11	50	600
4670	10 x 20	5 x 15,5	30	360
4675	10 x 25	5 x 20	30	360
4680	10 x 30	5 x 25	30	360
4685	10 x 35	5 x 30	30	360

Adhesive film dressings

evercare® adhesive film dressing

Transparent adhesive dressing

- Primary dressing for clean wounds
- Secondary dressing for fixation

Skin-friendly polyacrylate adhesive

Supporting release paper and paper frame for easy application

Flexible transparent shower proof covering

- Protects the wound
- Conforms to surface contours
- Barrier for fluid strike-through
- Breathable, allows excess moisture pass away



Adhesive film dressing

REF	Size cm	Pcs/box	Pcs/carton
4705	6 x 7	50	200
4710	10 x 12	25	100
4715	10 x 25	25	100
4720	15 x 20	25	100



Absorbent transparent dressings

evercare® transparent dressing with absorbent pad

Transparent self-adhesive absorbent film dressing for low to moderate exuding wounds

Absorbent wound pad with low adherent contact surface

- Patient comfort
- Longer wear time

Skin-friendly polyacrylate adhesive

Supporting release paper and paper frame for easy application

Flexible transparent shower proof covering

- Protects the wound
- Conforms to surface contours
- Barrier for fluid strike-through
- Breathable, allows excess moisture pass away

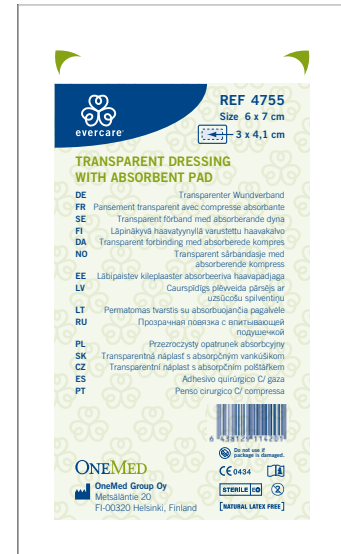

4761– 4769



4755, 4760, 4770



Transparent dressing with absorbent pad

REF	Size cm	Pad size cm	Pcs/box	Pcs/carton
4755	6 x 7	3 x 4	50	200
4760	10 x 12	4,5 x 6	25	100
4761	8,5 x 15,5	3,8 x 11	50	600
4762	10 x 20	5,3 x 15	25	100
4765	10 x 25	5,5 x 20	25	100
4767	10 x 30	5,5 x 25	25	100
4769	10 x 35	5,5 x 30	25	100
4770	15 x 20	8 x 10,5	25	100

Absorbent dressings

evercare® absorbent dressing

For heavily discharging wounds and open drains, no need for supplementary dressing in between

High absorption and retention capacity



Sterile



Non-sterile



Absorbent dressing, sterile

REF	Size cm	Pcs/box	Pcs/carton
4781	10 x 10	50	600
4782	10 x 20	35	420
4783	10 x 30	25	300
4784	15 x 20	25	300
4785	15 x 25	25	300
4786	20 x 20	25	300
4787	20 x 25	20	240
4788	20 x 30	20	240
4789	20 x 40	10	120

Absorbent dressing, non-sterile

REF	Size cm	Pcs/bag	Pcs/carton
4531	10 x 10	10	500
4532	10 x 20	10	500
4533	10 x 30	10	500
4534	15 x 20	5	200
4535	15 x 25	5	200
4536	20 x 20	5	200
4537	20 x 25	5	200
4538	20 x 30	5	200
4539	20 x 40	3	150

Label information in accordance with EN ISO 15223-1 and EN 1041

evercare® is a registered trademark of OneMed Group Oy

Article number



CE label: certifies that the product complies with the European legal requirements for medical devices

Does not contain natural rubber latex

Single use

Sterile

Manufacturers contact information

Wound care



Bandages



Elastic fixation bandages

evercare® Selexif elastic fixation bandage

- Composition 100 % polyester
- Available both sterile and unsterile
- Many applications
- Woven edges, white
- Soft and comfortable
- Highly elastic
- Extended length 4 m

Indications

- For fixation of all types bandages, especially of joints and round body parts
- Can even be used as a lighter pressure and compression bandage
- Securing, cannulae and paddings

Sterile

REF	Size	Pcs/dispenser	Pcs/transport carton
4130	4 cm x 4 m	25	100
4131	6 cm x 4 m	25	100
4132	8 cm x 4 m	25	100
4133	10 cm x 4 m	25	100
4134	12 cm x 4 m	25	100

Non-sterile

REF	Size	Pcs/dispenser	Pcs/transport carton
4181	4 cm x 4 m	20	600
4182	6 cm x 4 m	20	560
4183	8 cm x 4 m	20	480
4184	10 cm x 4 m	20	400
4185	12 cm x 4 m	20	320



evercare® Crepe elastic fixation bandage

- Composition 100 % polyester
- Very airy due wavy structure
- Comfortable
- Highly elastic
- Many applications
- Easy to apply
- Soft and breathable
- Non-slip fit
- Resistant to ointments
- Extended length 4 m

Indications

- For fixation of all types bandages, especially of joints and round body parts
- Securing compresses, cannulae and paddings

REF	Size	Pcs/dispenser	Pcs/transport carton
4161	4 cm x 4 m	20	600
4162	6 cm x 4 m	20	560
4163	8 cm x 4 m	20	480
4164	10 cm x 4 m	20	400
4165	12 cm x 4 m	20	320



Elastic fixation bandages

evercare® Fix Premium elastic fixation bandage

- Composition 60 % polyamide and 40 % viscose
- Available both bulk and single packed
- Easy to apply
- Soft
- Permeable to air
- Non-slip fit
- Sterilizable
- Resistant to ointments
- Extended length 4 m

Indications

- For fixation of all types bandages, especially of joints and round body parts
- Securing compresses, cannulae and paddings

Single packed

REF	Size	Pcs/dispenser	Pcs/transport carton
4110	4 cm x 4 m	20	720
4111	6 cm x 4 m	20	560
4112	8 cm x 4 m	20	480
4113	10 cm x 4 m	20	400
4114	12 cm x 4 m	20	320
4115	15 cm x 4 m	20	240
4116	20 cm x 4 m	20	240



Bulk packed

REF	Size	Pcs/dispenser	Pcs/transport carton
4150	4 cm x 4 m	20	720
4151	6 cm x 4 m	20	560
4152	8 cm x 4 m	20	480
4153	10 cm x 4 m	20	400
4154	12 cm x 4 m	20	320
4155	15 cm x 4 m	20	240
4156	20 cm x 4 m	20	240



Elastic support bandages

evercare® Ideal elastic support bandage

- Composition 100 % cotton
- With woven edges, beige
- Stable, conforms well and is comfortable to wear
- Available both sterile and unsterile
- Resistant to ointments
- Extended length 4 m

Indications

- Fixation of wound dressings, especially on joints
- As support in amputations and ligament injuries
- Fixation of splints
- To support, eg after plaster removal
- For compression in edema treatment



Sterile

REF	Size	Pcs/dispenser	Pcs/transport carton
4276	6 cm x 4 m	20	80
4277	8 cm x 4 m	20	80
4278	10 cm x 4 m	20	80
4279	12 cm x 4 m	20	80
4280	15 cm x 4 m	15	60

Non-sterile

REF	Size	Pcs/dispenser	Pcs/transport carton
4241	6 cm x 4 m	10	450
4242	8 cm x 4 m	10	370
4243	10 cm x 4 m	10	290
4244	12 cm x 4 m	10	230
4245	15 cm x 4 m	10	190



evercare® Ideal elastic support bandage

- Composition 62 % cotton, 30 % polyamide and 8 % elasthane
- With woven edges, white
- Stable, conforms well
- Comfortable to wear
- Resistant to ointments
- Extended length 4 m

Indications

- Fixation of wound dressings, especially on joints
- As support in amputations and ligament injuries
- Fixation of splints
- To support, eg after plaster removal
- For compression in edema treatment

REF	Size	Pcs/dispenser	Pcs/transport carton
4261	6 cm x 4 m	10	320
4262	8 cm x 4 m	10	240
4263	10 cm x 4 m	10	200
4264	12 cm x 4 m	10	160
4265	15 cm x 4 m	10	120



Elastic support bandages

evercare® Ideal cotton elastic support bandage

- Composition 100 % cotton
- With woven edges, natural white
- Stable, conforms well and is comfortable to wear
- Resistant to ointments
- Extended length 4 m

Indications

- Fixation of wound dressings, especially on joints
- As support in amputations and ligament injuries
- Fixation of splints
- To support, eg after plaster removal
- For compression in edema treatment



REF	Size	Pcs/dispenser	Pcs/transport carton
4246	6 cm x 4 m	10	320
4247	8 cm x 4 m	10	240
4248	10 cm x 4 m	10	200
4249	12 cm x 4 m	10	160
4250	15 cm x 4 m	10	120

evercare® elastic support bandage

- Composition 65 % cotton and 35 % polyamide
- Light support bandage
- With woven edges, white
- Conforms well and comfortable to wear, no restriction to freedom of movement
- Available both single and bulk packed
- Resistant to ointments
- Extended length 4 m

Indications

- Fixation of wound dressings, especially on joints
- Fixation of splints
- To support, eg after plaster removal
- Non-sterile



1-3 clips per
single packed bandage

Bandages

Single packed

REF	Size	Pcs/dispenser	Pcs/transport carton
4211	6 cm x 4 m	10	280
4212	8 cm x 4 m	10	240
4213	10 cm x 4 m	10	200
4214	12 cm x 4 m	10	160
4215	15 cm x 4 m	10	120
4216	20 cm x 4 m	10	120

Bulk packed

REF	Size	Pcs/dispenser	Pcs/transport carton
4251	6 cm x 4 m	10	280
4252	8 cm x 4 m	10	240
4253	10 cm x 4 m	10	200
4254	12 cm x 4 m	10	160
4255	15 cm x 4 m	10	120
4256	20 cm x 4 m	10	120



Permanent elastic compression and gauze bandages

evercare® Forte permanent elastic compression bandage

- Composition 85 % cotton, 7 % polyamide and 8 % elasthane
- Strong support bandage
- With woven edges, natural white
- 2 clips per bandage
- Porous
- Available both single and bulk packed
- Resistant to ointments and salves
- Extended length 7 m

Indications

- Treatment, after and care prevention of sports injuries
- Compression therapy
- Bandaging of joints in care of dislocations, luxations
- After varicose veins operations
- Haematoma



Single packed

REF	Size	Pcs/dispenser	Pcs/transport carton
4410	6 cm x 7 m	10	280
4411	8 cm x 7 m	10	240
4412	10 cm x 7 m	10	210
4413	12 cm x 7 m	10	160

Bulk packed

REF	Size	Pcs/dispenser	Pcs/transport carton
4450	6 cm x 7 m	10	280
4451	8 cm x 7 m	10	240
4452	10 cm x 7 m	10	210
4453	12 cm x 7 m	10	160

evercare® Fix gauze bandage

- Composition 100 % cotton
- Bulk packed
- Non-sterile

REF	Size	Pcs/dispenser	Pcs/transport carton
3905	5 cm x 10 m	50	500
3907	7 cm x 10 m	50	600
3909	10 cm x 10 m	50	300



Label information in accordance with EN ISO 15223-1 and EN 1041

evercare® is a registered trademark of OneMed Group Oy

evercare®

COMPOSITION PA 60%, CV 40%

REF 4110

SIZE 4 cm x 4 m (stretched)

ELASTIC FIXATION BANDAGE
Fix Premium

DE Elastische Fixierbinde
FR Bande élastique
SE Elastisk binda
FI Elastinen kiinnitysside
DA Elastisk fikseringsbind
NO Elastisk fikserbind
EE Elastne fikseerimisside
LV Elastīgā saite
LT Elastinis fiksuojančias tvarstis
PL Bandaż elastyczny podtrzymujący
RU Эластичный фиксирующий бинт
SK Elastické fixačné ovínadlo
CZ Elastické fixační obinadlo
ES Venda bielástica compresiva
PT Ligadura de compressão
NL Elastisch fixatieverband

LOT

Use before

[NATURAL LATEX FREE]

CE

ONE MED

OneMed Group Oy
Metsäläntie 20, FI-00320 Helsinki, Finland

6 438129 114560

Material composition

Article number

Size

Does not contain natural rubber latex

Single use

CE label: certifies that the product complies with the European legal requirements for medical devices

Manufacturers contact information

All evercare® bandages are
[NATURAL LATEX FREE]



OneMed Group Oy
P.O.Box 10 (Metsäläntie 20), FI-00321 Helsinki
www.onemed.com

Phone +358 46 714 6800
info.group@onemed.com

ONEMED